



Chicago Dermatological Society

January 2011
Coding and
Practice Management Seminar

*Saturday, January 22, 2011
Donald E. Stephens Convention Center
Rosemont, IL*

Table of Contents

5	Program
7 - 8	Continuing Medical Education Information and Accreditation Statement
9 - 40	Dermatology Coding 101: The Basics Boot Camp
41 - 65	Coding and Health System Reform Update
67 - 104	Coding Soup for Dermatology
105 - 118	Electronic Health Records and Meaningful Use
119 - 122	Additional Materials/Article



Chicago Dermatological Society

10 W. Phillip Rd., Suite 120 ❖ Vernon Hills, IL 60061-1730
(847) 680-1666 ❖ Fax: (847) 680-1682
Email: RichardPaul@dls.net ❖ Internet: www.ChicagoDerm.org

2011 CDS Coding Seminar Saturday, January 22, 2011 ❖ Stephens Convention Center; Rosemont, IL **PROGRAM**

7:30 a.m.	Registration, continental breakfast & visit with exhibitors <i>Ballroom 21, Level 2</i>
8:00 a.m. - 9:00 a.m.	Coding 101 -- The Basics Boot Camp <i>DANIEL SIEGEL, MD; PEG EIDEN & FAITH MCNICHOLAS</i> <i>Ballroom 21, Level 2</i>
9:00 a.m. - 10:00 a.m.	Alphabet Soup: CPT, ICD, PQRI, CMS and More! -- What's New and What You Need to Know to Comply With Medicare Rules <i>DANIEL SIEGEL, MD, PEG EIDEN & FAITH MCNICHOLAS</i> <i>Ballroom 21, Level 2</i>
10:00 a.m. - 10:20 a.m.	Break <i>Ballroom 21, Level 2</i>
10:20 a.m. - 12:00 p.m.	Coding Issues, continued Questions & Answers <i>DANIEL SIEGEL, MD, PEG EIDEN & FAITH MCNICHOLAS</i> <i>Ballroom 21, Level 2</i>
	e-Prescribing and How EMR Will Affect a Clinical Practice <i>RACHNA CHAUDHARI; AMERICAN ACADEMY OF DERMATOLOGY</i>
12:00 p.m.	Meeting Adjourns

Mark the Date!

Next CDS monthly meeting – Wednesday, March 2, 2011 at Stroger Hospital of Cook County;
Timothy G. Berger, MD from the University of California-San Francisco

Please note the following date change . . .

The May monthly meeting sponsored by Rush University is now on Wednesday, May 11 at the
Stephens Convention Center in Rosemont.

Watch for details on the CDS website: www.ChicagoDerm.org

Continuing Education Credit

Chicago Dermatological Society "Chicago Dermatological Society Monthly Conference"

January 22, 2011

Rosemont, IL

Participants must attend entire session to receive all types of credit. CFMC hosts an online evaluation system, certificate and outcomes measurement process. Following the conference, you must link to CFMC's online site (link below) to complete an evaluation form, in order to receive your continuing education statement of hours (certificate). Once the evaluation form is complete, you will automatically be sent a copy of your certificate via email.

Continuing Education evaluation and request for certificates will be accepted up to 60 days post activity date. The Colorado Foundation of Medical Care (CFMC) will keep a record of attendance on file for 6 years. CFMC contact information: 303-695-3300, ext. 3139.

Link address to evaluation form:

www.yourcesource.com/eval?act=473!01222011

JOINT SPONSOR STATEMENT



This Continuing Educational activity is Joint-sponsored by the **Colorado Foundation for Medical Care, Office of Continuing Education** and the **Chicago Dermatological Society**. CFMC is accredited by the **ACCME** to provide continuing medical education for physicians.

GOAL/PURPOSE

To broaden the clinical knowledge of dermatologists with respect to diagnostic.

SESSION OBJECTIVES

Upon completion of sessions, participants will be able to apply new knowledge and skills in the area of physician learning.

After participating in this program, physicians should be able to:

1. Describe the rules pertaining to proper coding for dermatological services.
2. Discuss the importance of accurate chart documentation so that it accurately reflects care provided to a patient.

3. Demonstrate how a dermatologist can effectively integrate e-prescribing and electronic medical records into his/her practice.

CREDIT STATEMENTS



CME CREDIT

This activity has been planned and implemented in accordance with the Essential Areas and policies of the Accreditation Council for Continuing Medical Education (ACCME) through joint sponsorship of the Colorado Foundation for Medical Care, Office of Continuing Education (CFMC OCE) and Chicago Dermatological Society. CFMC is accredited by the ACCME to provide continuing medical education for physicians.

Colorado Foundation for Medical Care designates this educational activity for a maximum of **4 *AMA PRA Category 1 Credits***[™]. Physicians should only claim credit commensurate with the extent of their participation in the activity.

CFMC has no financial responsibility for this activity.

OTHER HEALTH CARE PROFESSIONALS

This educational activity has been planned and implemented following the administrative and educational design criteria required for certification of health care professions continuing education credits. Registrants attending this activity may submit their certificate along with a copy of the course content to their professional organizations or state licensing agencies for recognition for 4 hours.

DISCLOSURE STATEMENTS

All members of the faculty and planning team have nothing to disclose nor do they have any vested interests or affiliations. **It is the policy of the Colorado Medical Society and Colorado Foundation for Medical Care (CFMC) that the faculty discloses real or apparent conflicts of interest relating to the topics of the educational activity, and also discloses discussions of off-label uses of drugs and devices before their presentation(s).**

Acknowledgment

Grateful acknowledgement is given to Chicago Dermatological Society exhibitors for their participation and support of this educational activity.

**Dermatology
Coding 101:
The Basics Boot Camp**

 *American Academy of Dermatology Association*
Physicians Dedicated to Excellence in Dermatology™

Dermatology Coding 101

Chicago Dermatological Society
Saturday, January 22, 2011

Faith C. M. McNicholas, CPC, CPCD, PCS, CDC
Manager – Coding & Reimbursement/Govt. Affairs

Objective

- Introduction to ICD-9-CM, CPT, HCPCS
- Understanding ICD-9-CM, CPT, HCPCS codebooks organization
- Classification and use of specific codes
- Guidelines
- Appropriate use of codes

 *American Academy of Dermatology*
Physicians Dedicated to Excellence in Dermatology™

What is ICD-9- CM?

- ✓ International Statistical Classification of Diseases and Related Health Problems - 9th Revision
- ✓ Alphanumeric statistical system for coding every disease, description of symptom, abnormal finding, complaint, social circumstance, external cause and cause of injury, disease or death afflicting human beings, **as classified by the World Health Organization**



 *American Academy of Dermatology*
Physicians Dedicated to Excellence in Dermatology™

ICD-9- CM? Cont...

- ✓ Provides code titles and language that **complement accepted clinical practice** in the U.S.
- ✓ Includes the level of detail needed for morbidity classification and diagnostic specificity in the United States
- ❖ **ICD-9-CM is maintained by the U.S. National Center for Health Statistics (NCHS)**

4

 American Academy of Dermatology

ICD-9-CM Organization

➤ Introduction	➤ Valid Three-digit Code Table
➤ Official ICD-9-CM Conventions	➤ Coding Guidelines
➤ Additional Convention	➤ Disease Classification: Alphabetic Index
➤ Summary of Code Changes	➤ Disease Classification: Tabular List

5

 American Academy of Dermatology Association

Basic steps to ICD-9-CM Coding

- **Alphabetic Index – Volume 2**
 - ✓ **Identify reason for the encounter**
 - ✓ **Always** consult Alphabetic Index – Volume 2 – **first**
 - ✓ Locate main entry term

6

 American Academy of Dermatology Association

ICD-9-CM Symbols

- ▶◀ Denotes revised text
- Denotes new line
- ▲ Denotes revised code
- 4th 4th digit required
- 5th 5th digit required
- Denotes exclusion
- Denotes inclusion

10



ICD-9-CM Tabular List

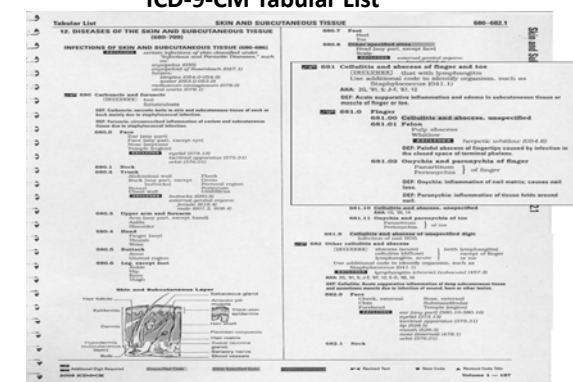

11

General ICD-9-CM Coding

- Diagnostic codes to be assigned at their **highest** level of specificity
- Assign **principal code** to report **reason for encounter**
- **Do not** assign three-digit codes when four- or five-digit codes available in same category
- When definitive diagnosis is established, **it's not appropriate** to report signs and symptoms code

12



General ICD-9-CM Coding

- **NEC - "Not elsewhere classifiable"** – use **only** when information available specifies a condition that has no distinctive code
- **Other Code** - use when available information provides detail for which a specific code does not exist.
- **NOS – "Not otherwise specified"/ Unspecified** - use **only** when inadequate information to allow specific code assignment
- **Includes, Excludes notes** – defines or clarifies content of the chapter, category etc

13

AAD American Academy of Dermatology and AAD Association
Professionals Dedicated to Excellence in Dermatology

General ICD-9-CM Coding

- **Use additional code** – when directed additional code required when information is available
- **Code first the underlying disease** – is a sequencing rule
- **Casual condition first** – code may be assigned as principal diagnosis
- **Omit code** – denotes no code assignment
- **See condition** – refer to main term

14

AAD American Academy of Dermatology and AAD Association
Professionals Dedicated to Excellence in Dermatology

Pitfalls in ICD-9-CM Usage

- Avoid code **overuse**
- Avoid using **generic** codes
- **Overuse** of codes can **build profiles**
- **Never use code** as primary diagnosis when documented as 'probable', 'suspected', 'questionable' or 'rule out'

15

AAD American Academy of Dermatology and AAD Association
Professionals Dedicated to Excellence in Dermatology

Correct ICD-9-CM coding

- Code and report treated chronic conditions
- List ancillary diagnostic/therapeutic service as secondary code to problem for which services are being performed
- Patients receiving surgery – code diagnosis for which surgery is being performed
- Document and code all co-existing conditions

ICD-9-CM Coding Tips

- Conduct periodic reviews of the medical record to determine coding accuracy
- Establish **medical necessity** for the services to be provided
- Check for **gender** sensitive codes
- **Unsure of coverage** - check payer coverage policy prior to providing service

Current Procedural Terminology (CPT)

- Set of codes, descriptions and guidelines
- Identified with a five digit code
- Descriptor and code inclusion based on procedure being **consistent with contemporary medical practice**
- Published annually
- Codes effective for use beginning **January 1st**
- CPT Category II and III released twice a year



CPT Code Book Organization

- Six sections subdivided into subsections
- Procedures and services codes presented in numeric order
- **Exception – Evaluation and Management** appears at beginning of listed procedures
- Used by most qualified healthcare providers to report their services

19

AAD American Academy of Dermatology and AAD Association
Procedures Coded and Reported by Dermatologists

CPT Code Book Sequencing

- **Category I**
 - ✓ **Evaluation & Management** 99201 - 99499
 - ✓ **Anesthesiology** 00100 - 01999, 99100 - 99140
 - ✓ **Surgery/Integumentary** 10021 - 69990
 - ✓ **Radiology** 70010 - 79999
(Incls. Nuclear Meds. & Diagnostic Ultrasound)
 - ✓ **Pathology & Laboratory** 80048 - 89356
 - ✓ **Medicine** 90281 - 99199, 99500 - 99602

20

AAD American Academy of Dermatology and AAD Association
Procedures Coded and Reported by Dermatologists

CPT Coding for Dermatology

- More than 7,000 CPT codes, dermatology only uses about 400 routinely
- Dermatology codes primarily located in the **Surgery/Integumentary** section of the AMA CPT code book
- Descriptions and assigned codes for every procedure/service performed by qualified healthcare providers are found in the AMA/CPT® code book

21

AAD American Academy of Dermatology and AAD Association
Procedures Coded and Reported by Dermatologists

Overview

- Dermatology - the study of skin, its structure, functions and diseases
- Significant proportion of invasive procedures involve integumentary system
- Due to sophistication, integumentary procedures/services often performed in staged sequence
- Due to changes in technology, medical practice should be accurately reflected in CPT coding

22

AAD American Academy of Dermatology and AAD Association
Procedures Coded and Billable in Dermatology

General CPT/Dermatology Coding Guidelines

- CPT - national standard for identifying and billing **procedural services** in the US health care industry
- Each service is considered on its own merit
- Code listings in particular subsections do not restrict the code use to a specific specialty
- Services performed using a combination of procedures may require multiple codes

23

AAD American Academy of Dermatology and AAD Association
Procedures Coded and Billable in Dermatology

CPT Code Book Sequencing

- **Category II** **0001F - 6020F**
 - ✓ Set of **supplemental** tracking codes
 - ✓ Listed as 4 digits followed by letter 'F'
- **Category III** **0016T - 0183T**
 - ✓ Set of **temporary** codes
 - ✓ Listed as 4 digits followed by letter 'T'

24

AAD American Academy of Dermatology and AAD Association
Procedures Coded and Billable in Dermatology

CPT Code Book Sequencing

- **Appendix A** **Modifiers**
- **Appendix B** **Summary of additions, Deletions & Revisions**
- **Appendix C** **Clinical Examples**
- **Appendix D** **Summary of Add-on Codes**

25

 *American Academy of Dermatology*

CPT Code Book Sequencing

- **Appendix E** **Summary of Modifier 51 Exempt**
- **Appendix F** **Summary of Modifier 63 Exempt**
- **Appendix G** **Summary of Codes that incl. Cons. Sedations**
- **Appendix H** **Alpha-Index of Performance Measures**

26

 *American Academy of Dermatology*

CPT Code Symbols

- Identifies new code
- ▲ Identifies a revised code
- + Identifies an add-on code
- ▶◀ Identifies new or revised text
- Identifies modifier 51 exempt

27

 *American Academy of Dermatology*

Use of CPT Codebook

- Identify **main procedural term** from **Alphabetical Index** before turning to Tabular Listing for code
- Select accurate name of procedure/service
- Read and understand the **notes** included with procedure codes
- Read and understand specific **coding guidelines** preceding each section

28

AAD American Academy of Dermatology

Use of CPT Codebook

- **Add-on Codes**
 - ✓ Procedures performed in addition to primary procedure
- **Modifiers**
 - ✓ Provides means to report or indicate procedure has been altered **but not** changed
- **Unlisted Procedures**
 - ✓ Services/procedures that are not found in CPT codebook

29

AAD American Academy of Dermatology

CPT Format of Terminology

- Codes are listed from left to right
- **Indented code** extension of text preceding semicolon (;)
- ✓ **Example:-**
 - 12001 Simple repair of superficial...
 wounds of face; 2.5cm or less
 - 12002 2.6cm to 7.5cm

30

AAD American Academy of Dermatology

Summary

- **ICD-9-CM**
 - ✓ Official system of assigning codes to diagnoses and procedures associated with hospital utilization in the United States
- **Current Procedural Terminology**
 - ✓ Descriptions and assigned codes for every procedure that is performed by a qualified healthcare provider
- **HCPCS**
 - ✓ Identification of items or services provided by qualified healthcare providers

37

AAD American Academy of Dermatology and AAD Association

Resources

**ICD-9-CM Volumes 1&2,
9th Revision – Clinical Modification**

AMA CPT 2008 – Professional Edition

**AMA HCPCS – Medicare National
Level II Codes**

www.ama-assn.org

38

AAD American Academy of Dermatology and AAD Association

Objective

- Identify and use the dermatologic and integumentary specific sections of CPT, ICD-9-CM and HCPCS;
- Recognize the relationship between CPT and ICD-9 coding and apply proper CPT, ICD-9-CM and HCPCS codes to services and procedures performed in a dermatology practice;
- Apply appropriate CPT coding guidelines for dermatologic procedures and understand the use of modifiers to clarify problematic/complex coding scenarios.

39

AAD American Academy of Dermatology Association

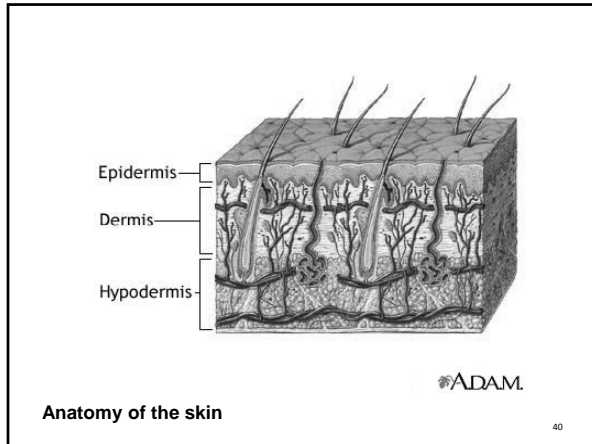

Skin Diseases

- Acne
- Warts
- Rash
- Lesions
 - ✓ Actinic Keratoses
 - ✓ Nevus
 - ✓ Lupus Lesions

AAD American Academy of Dermatology and AAD Association

41

Skin Diseases

Acne

Warts

Actinic Keratoses

Halo nevus

AAD American Academy of Dermatology and AAD Association

42

Code Classification – Acne Surgery

- Acne Surgery – **10040**
 - ✓ Contact patient insurance carrier for verification of coverage
 - ✓ Evaluate and document what transpired during the encounter
 - ✓ Select level of service

43

AAD American Academy of Dermatology

Code application

- 706.1 – Acne NOS
- 992xx - 25 - New or Est. Office/other Pt. Visit
- 36415 – Blood draw by venipuncture
- 81025 – Pregnancy test by visual color comparison

44

AAD American Academy of Dermatology and AAD Association

Biopsy - Skin

- **11100 – 11101**
 - ✓ Codes **include** simple closure
 - ✓ Designated as **separate procedure**
 - ✓ Reported for single lesion (each)
 - ✓ Report only when most specific anatomic area code is not available
 - ✓ can be done by either shave or punch **technique**

45

AAD American Academy of Dermatology

Code application

- ✓ 992xx - 25 - New or Est. Office/other Pt. Visit
- ✓ 11100 – 59 – Biopsy of skin (each)
- ✓ 11101 each add'l biopsy (when appropriate)
- ✓ 17110 – Destruction, benign lesion >14
- ✓ 17000 – 59 – Destruction, premalignant lesion

46

AAD American Academy of Dermatology

Anatomical Biopsies

- Biopsy of the penis – 54100
- Biopsy, vulva or perineum – 5660x each
- Biopsy of the eye – 67810
- Biopsy of the Lip – 40490
- Biopsy of external ear - 69100

47

AAD American Academy of Dermatology and AAD Association

Skin Tag Removal

- **11200 – 11201**
 - ✓ Removal may be by any sharp method, ligature strangulation, electrosurgical destruction or a combination of treatment modalities
 - ✓ Reported for removal of skin tags from any body area

48

AAD American Academy of Dermatology Association

Shaving – Epidermal/Dermal Lesions

➤ **11300 – 11313**

- ✓ Codes normally reserved for lesions at the upper layers of the skin
- ✓ Shaved lesions usually will not involve suture closure
- ✓ **Includes** local anesthesia and any chemical or electro cauterization
- ✓ Codes reported based on **anatomic area** and **size** of lesion

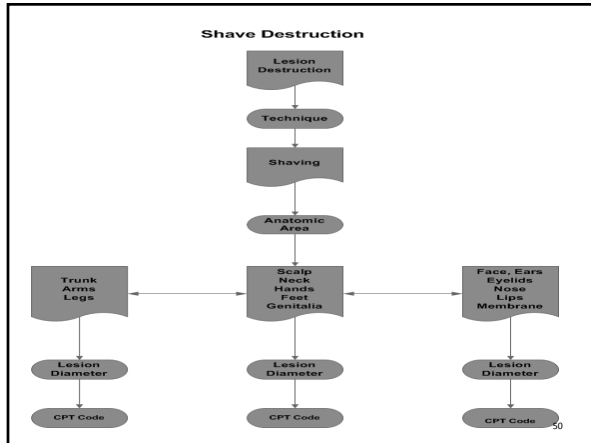

Shave vs Biopsy

➤ **Documentation Confusion**

- ✓ Shave Biopsy – may interpret as shave removal
- ✓ Punch Biopsy
- ✓ Excisional Biopsy

❖ **Consider** documenting - **Biopsy by shave technique**

Note – Intent of procedure will determine code selection.

Removal of a Lesion

- Document **size and location** of lesion
- Size measured by clinical diameter
- accurate measurement is most achieved at time of excision
- pathology report **will not** provide accurate measurement due to shrinkage/ fragmentation of specimen

52

AAD American Academy of Dermatology Association
Physicians Dedicated to Excellence in Dermatology

Measuring of lesion

- Excised diameter 0.6cm + 0.4cm (0.2cm margin) = 1.0 cm

Figure 1

The diagram shows a central black oval representing a lesion. A dashed rectangle surrounds it, representing the excised area. The width of the lesion is labeled as 0.6 cm. The width of the excised area is labeled as 1.0 cm, with a note '1.0 cm lesion plus margin s (excised diameter)'. The distance from the lesion to the edge of the excised area is labeled as 0.2 cm margin on both the top and bottom sides.

53

AAD American Academy of Dermatology Association
Physicians Dedicated to Excellence in Dermatology

Code Application

- ✓ 216.x – Benign neoplasm of skin
- ✓ 1144x – Excision, benign lesion incl. margins

54

AAD American Academy of Dermatology and AAD Association
Physicians Dedicated to Excellence in Dermatology

Measuring of lesion

➤ Excised diameter 2.1cm + 0.6 cm (0.3cm margin)

Figure 2

The diagram shows a central black oval representing a lesion, labeled '2.1 cm lesion'. This lesion is enclosed within a larger dashed-line oval representing the excised area, labeled '2.7 cm lesion plus margins (excised diameter)'. The distance between the lesion and the excised boundary is labeled '0.3 cm margin' on both the top and bottom sides. The total width of the excised area is also labeled '2.7 cm lesion plus margins (excised diameter)'.

55

Code application

- ✓ 216.5 - Benign neoplasm of skin, trunk
- ✓ 11403 – Excision, benign lesion incl. margins, trunk

56

American Academy of Dermatology and AAD Association

Excisions – Benign Lesions

➤ 11400 – 11446

- ✓ coded by site and size of lesion
- ✓ Includes simple closure **and** local anesthesia
- ✓ If layered closure required, appropriate repair code should be **reported in addition** to excision code

57

American Academy of Dermatology Association

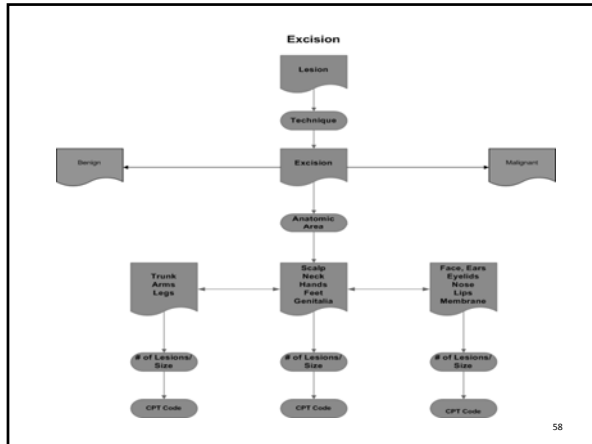

Code Application

- 2 cm benign lesion excised from the face and a 4 cm layered closure performed.
 - ✓ 11442 - excision of the benign lesion
 - ✓ 12052 - intermediate repair of defect.

59

AAD American Academy of Dermatology and AAD Association

Excisions – Benign Lesions

- If **more than one** lesion excised - report **each** excised lesion separately
- Lesions with **extended** margins during same operative session - only **one** code would be reported
- ◆ **Most common misconception** - multiple lesion **excisions** are **added** together and reported as **one** code

60

AAD American Academy of Dermatology and AAD Association

Excisions – Benign Lesions

- **Two** lesions removed by one excision – report **one** excision code reflecting **maximum** diameter
- **Re-excision** of lesion- report **appropriate diagnosis** code; use modifier if on different date

61

AAD American Academy of Dermatology and AAD Association
Physicians Dedicated to Excellence in Dermatology

2 lesions, one excision

0.5 cm + 0.5 cm + 1.0cm = 2 cm

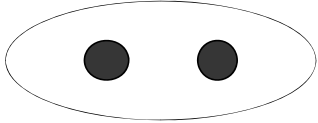

62

AAD American Academy of Dermatology and AAD Association
Physicians Dedicated to Excellence in Dermatology

Code Application

- Two 0.5cm facial lesions - 1cm apart
- Removed with Single excision
- 0.5cm + 0.5cm + 1cm = 2.0cm (diameter)
- **Report CPT 11442**

63

AAD American Academy of Dermatology and AAD Association
Physicians Dedicated to Excellence in Dermatology

Excisions – Malignant Lesions

➤ **11600 – 11646**

- ✓ reported by **site and size** of lesion
- ✓ Includes simple closure **and** local anesthesia
- ✓ If layered closure required, appropriate repair code should be reported **in addition** to excision code

Note: CMS will not reimburse repair for defect less than 0.5cm

64

AAD American Academy of Dermatology and AAD Association

Code Application

➤ **2.0 cm** malignant lesion excised from the face and a **4 cm** layered closure performed.

- ✓ **11642** - excision of the malignant lesion
- ✓ **12052** - intermediate repair of defect

65

AAD American Academy of Dermatology and AAD Association

Lesion Destruction

➤ Defined as the ablation of benign, pre-malignant, malignant tissue **by any method**

➤ Any method - electrosurgery, cryosurgery, laser & chemical treatment

➤ with/without curettage, including local anesthesia, usually not requiring closure

➤ Destruction of lesion in specific anatomic sites, see appropriate location in CPT

66

AAD American Academy of Dermatology and AAD Association

Destructions – Pre-malignant Lesions

➤ **17000 – 17004**

- ✓ Only appropriate to report for pre-malignant lesion destruction e.g **Actinic Keratoses**
- ✓ **Actinic Keratoses** lesions treated with Photodynamic Therapy – **see 96567**
- ✓ Reporting **based on the number** of lesions

Note: Appropriate ICD-9 Code - 702.0

67

AAD American Academy of Dermatology and AAD Association
Procedures Submitted to Committee on Terminology

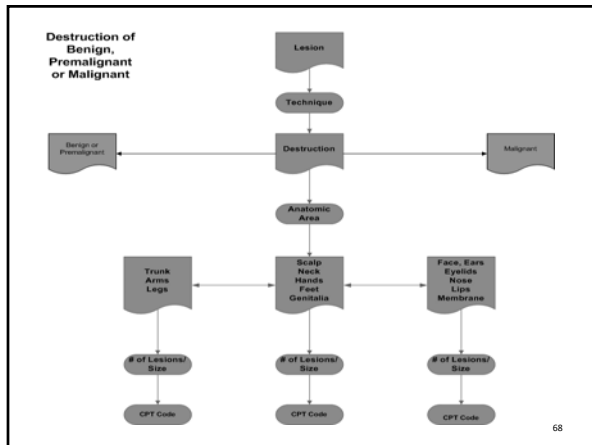

Destruction – Cutaneous Vascular Proliferative lesions

➤ **17106 – 17108**

- ✓ **Specific** to destruction of cutaneous vascular proliferative lesions
- ✓ Reporting is based on treated area measured **square centimeters**
- ✓ Only **one** code required for the **total area** treated

69

AAD American Academy of Dermatology and AAD Association
Procedures Submitted to Committee on Terminology

Destruction – Benign Lesions

➤ **17110 - 17111**

- ✓ Appropriate to report for destruction of **all other benign** lesions e.g warts, SK's
- ✓ **Establish and document** medical necessity in medical record
- ✓ Some payers perform **pre-payment audits**
- ✓ Reporting **based on the number** of lesions

70

AAD American Academy of Dermatology and AAD Association
Physicians Dedicated to Excellence in Dermatology

Code application

➤ **702.11** – Seborrheic Keratosis, inflamed

- ✓ **17110** – Destruction, Benign lesions, up to 14
- ✓ **17111** – Destruction, Benign lesions, 15 or more lesions

71

AAD American Academy of Dermatology and AAD Association
Physicians Dedicated to Excellence in Dermatology

Destruction – Malignant Lesions

➤ **17260 – 17286**

- ✓ Reporting based on **size and anatomic** area of lesion
- ✓ Describes **any method** of destruction
- ✓ **Pathology report** identifying malignancy **must be present** to report code

72

AAD American Academy of Dermatology and AAD Association
Physicians Dedicated to Excellence in Dermatology

Nails

- **11719** – Trimming, non-dystrophic
 - ✓ Reported **only** once
- **11720 – 11721** – debridement, any method
 - ✓ Reporting based on number of nails debrided
- **11730 - 11732** – Avulsion, nail plate
 - ✓ Reporting is based on number of nails

73

AAD American Academy of Dermatology and AAD Association
Procedures Categorized by Extent of Examination

Intralesional Injection

- **11900 – 11901**
 - ✓ Appropriate for **intralesional injection**
 - ✓ Reporting based on **number of lesions** injected
 - ✓ **Number of injections does not** factor in code selection
 - ✓ **Not to be used** for reporting **preoperative local anesthetic** injection

74

AAD American Academy of Dermatology and AAD Association
Procedures Categorized by Extent of Examination

Code Application

<ul style="list-style-type: none"> ✓ 078.10 – Viral wart, unsp ✓ J9040 – Bleomycin per 15 units ✓ 11900 – Intralesional injection (Up to & incl. 7 lesions) 	<ul style="list-style-type: none"> ✓ 696.1 – Psoriasis NOS ✓ J1438 – Enbrel ✓ 11901 - Intralesional injection (more than 7 lesions)
---	---

75

AAD American Academy of Dermatology Association
Procedures Categorized by Extent of Examination

Repairs

- Codes used to designate wound closure
- Closure by **adhesive strip** – report appropriate **evaluation & management code**
- In **single operative** procedure, **more than one method used**
 - ✓ report **only one** code based on **classification** of repair - **location and size**

76

AAD American Academy of Dermatology Association
Physicians Dedicated to Excellence in Dermatology

Repairs

- Three classifications of repair
 - ✓ **Simple Repair** -12001-12018 series
 - ✦ usually superficial wound
 - ✓ **Intermediate Repair** – 12031-12057 series
 - ✦ **one or more** of the **deeper layers** in subcutaneous tissue and superficial fascia
 - ✓ **Complex Repair** - 13100 -13153 series
 - ✦ **more than layered closure** (involves extensive undermining, stent or retention sutures)

77

AAD American Academy of Dermatology and AAD Association
Physicians Dedicated to Excellence in Dermatology

Repairs

- Codes reported based on the **sum of lengths** for the repairs
- **Multiple** wounds repaired – report one code
 - ✓ **sum** of lengths for repairs in **same classification** and **grouped anatomic sites**
 - ✓ **Do Not** add lengths of repairs from **different groups** of anatomic sites or **classifications**

78

AAD American Academy of Dermatology and AAD Association
Physicians Dedicated to Excellence in Dermatology

Code Application

- 2 benign lesions from forehead and cheek each 1cm;
- both require intermediate closure.
- One closure 4cm, the other 6cm

- ✓ **Add** both closures = 10cm
- ✓ closure is within same classification (intermediate) & anatomic site
- ✓ **report** 12054 plus 11441, 11441-59

79

AAD American Academy of Dermatology and AAD Association

Complicated Repairs

- Adjacent Tissue Transfer - 14000 series
 - ✓ Reporting based on anatomic site and size
 - ✓ Size refers to defect – not lesion
 - ✓ Excision not reported separately
 - ✓ Laceration repair – procedure must be performed by surgeon to accomplish repair

80

AAD American Academy of Dermatology and AAD Association

Excision with Adj. Tissue Transfer

- Incision performed **together** with adjacent tissue transfer – **report only** the adjacent tissue transfer
 - ✓ Lesion excision performed at same time as ATT **not** separately reported

81

AAD American Academy of Dermatology and AAD Association

Complicated Repairs

- **Grafts – 15000 series**
 - ✓ **Size** and **location** of recipient site
 - ✓ **Type** of graft/skin substitute
 - ✓ **Includes** simple debridement
 - ✓ Graft/skin substitute **must be affixed** to the skin
 - ✓ Do **not** report when skin substitute is **anchored** with dressing

82

AAD American Academy of Dermatology and AAD Association
Physicians Dedicated to Excellence in Dermatology

Skin Cancers

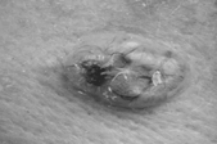

Basal Cell Carcinoma

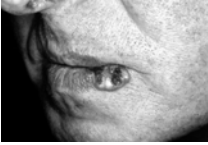

Squamous Cell Carcinoma

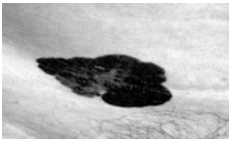

Melanoma

83

Summary

- ✓ Medical necessity must be documented
- ✓ Report codes that reflect type of service accurately
- ✓ Caution when reporting gender sensitive codes
- ✓ Codes are specified by site and size
- ✓ Do not hesitate to append modifier when justified
- ✓ Capture common and frequent procedures

84

AAD American Academy of Dermatology Association
Physicians Dedicated to Excellence in Dermatology

Other Resources

ICD-9-CM Volumes 1&2,
9th Revision – Clinical Modification

AMA CPT 2008 – Professional Edition

**AMA HCPCS – Medicare National
Level II Codes**

www.ama-assn.org

85

AAD American Academy of Dermatology and AAD Association
Physicians Dedicated to Excellence in Dermatology

Good News!

All the 3 Code books required for **effective and accurate coding** in Dermatology practices have been compressed into **one easy to use book.**

Order a copy for your practice Now!
2011 AAD Coding & Documentation Manual
at
www.aad.org/education/resources/index.html

Or call
866-503-7546 ext. 4000

86

AAD American Academy of Dermatology and AAD Association
Physicians Dedicated to Excellence in Dermatology

AAD Derm Coding Consult

For the latest Coding Updates - Derm Coding Consult

Free Member publication every quarter!

www.aad.org/members/publications/consult.html

Or call
866-503-7546 ext. 4000

87

AAD American Academy of Dermatology and AAD Association
Physicians Dedicated to Excellence in Dermatology

Webinars Coming Up.....

❖ **Mark your calendars!**

- 04/21/11 Getting Ready for ICD-10
- 09/22/11 Surviving a payer Audit w/AAD Audit Tool
- 11/17/11 CPT/ICD 2012 Coding Updates

**All Webinar sessions begin at:
12:00pm CDT**

AAD American Academy of Dermatology and AAD Association
Physicians Dedicated to Excellence in Dermatology

Contact Information

Faith C. M. McNicholas, CPC, CPGD, PCS, CDC

Peggy Eiden, CCS-P, CPC

Cindy Bracy, RHIA

 **847-330-1120**

 **ppm1@aad.org**

AAD American Academy of Dermatology Association
Physicians Dedicated to Excellence in Dermatology

Coding and Health System Reform Update

Coding and Health System Reform Update

Daniel Mark Siegel MD
 Clinical Professor Of Dermatology
 SUNY Downstate, Brooklyn, NY
 Private Practice, Smithtown, NY

New/Established Status Quo

Office or Other Outpatient Services						
Patient: New						
Required Components: 3/3						
Code	10256	00256	00256	10256	00256	
Required Key Components	History and Exam (#1 and #2)					
	Problem Focused	x				
	Expanded Problem Focused		x			
	Detailed			x		
Comprehensive				x	x	
Required Key Components	Medical Decision Making (#3)					
	Straightforward	x	x			
	Low			x		
	Moderate				x	
High					x	
Required Key Components	Presenting Problem (Severity) (#1)					
	Self-Limited or Minor	x				
	Low to Moderate		x			
	Moderate			x		
Moderate to High				x	x	
Commutative Factors	Counseling and Coordination of Care (#2 and #3) See E/M Guidelines					
	Typical Face-to-Face Time (#4)					
	Minutes	10	20	30	45	60

Office or Other Outpatient Services						
Patient: Established						
Required Components: 2/3						
Code	11256	21256	01256	11256	01256	
Required Key Components	History and Exam (#1 and #2)					
	Problem Focused	NA	x			
	Expanded Problem Focused			x		
	Detailed				x	
Comprehensive					x	
Required Key Components	Medical Decision Making (#3)					
	Straightforward	NA	x			
	Low			x		
	Moderate				x	
High					x	
Required Key Components	Presenting Problem (Severity) (#1)					
	Minimal		x			
	Self-Limited or Minor			x		
	Low to Moderate				x	
Moderate to High					x	
Commutative Factors	Counseling and Coordination of Care (#2 and #3) See E/M Guidelines					
	Typical Face-to-Face Time (#4)					
	Minutes	5	10	15	25	45

Other E&M

- Consultations are still in the book.
- CMS does not pay for them and many other are following suit.
- Inpatient codes were changed in 2010.
- New observation codes not likely to be used by us.

<http://www.aad.org/members/marketplace.html>



Coding Changes

10021 Fine needle aspiration; without imaging guidance
 ↻ CPT Assistant Aug 02:10, Mar 05:11; CPT Changes: An Insider's View 2002
 ↻ Clinical Examples in Radiology Fall 08:4

10022 with imaging guidance
 ↻ CPT Assistant Nov 02:1, Jun 07:10; CPT Changes: An Insider's View 2002
 ↻ Clinical Examples in Radiology Summer 05:1, 6, Summer 08:5, Fall 08:2, 3, 4

(For placement of percutaneous localization clip during breast biopsy, use 19295)
 (For radiological supervision and interpretation, see 76942, 77002, 77012, 77021)

▶(For percutaneous needle biopsy other than fine needle aspiration, see 20206 for muscle, 32400 for pleura, 32405 for lung or mediastinum, 42400 for salivary gland, 47000 for liver, 48102 for pancreas, 49180 for abdominal or retroperitoneal mass, 50200 for kidney, 54500 for testis, 54800 for epididymis, 60100 for thyroid, 62267 for nucleus pulposus, intervertebral disc, or paravertebral tissue, 62269 for spinal cord)◀

0.008% of 40,000

- Verbiage refined to differentiate from other needle biopsies.



Debridement Descriptions Refined

- Wound debridements (11042-11047) are reported by depth of tissue that is removed and by surface area of the wound.
- When performing debridement of a single wound, report depth using the deepest level of tissue removed.
- In multiple wounds, sum the surface area of those wounds that are at the same depth, but do not combine sums from different depths.



Debridement Descriptions Refined

- These services may be reported for injuries, infections, wounds and chronic ulcers.
- If multiple wounds are debrided on the same day, use modifier 59 with all 11xxx.



New Codes – Not for Us

- ▲ **11010** Debridement including removal of foreign material at the site of an open fracture and/or an open dislocation (eg, excisional debridement); skin and subcutaneous tissues
 ↻ CPT Assistant Mar 97:2, Apr 97:10, Aug 97:6, Oct 03:10;
 CPT Changes: An Insider's View 2011
- ▲ **11011** skin, subcutaneous tissue, muscle fascia, and muscle
 ↻ CPT Assistant Mar 97:2, Apr 97:10, Aug 97:6; CPT Changes:
 An Insider's View 2011
- ▲ **11012** skin, subcutaneous tissue, muscle fascia, muscle, and bone
 ↻ CPT Assistant Mar 97:2, Apr 97:10, Aug 97:6, Oct 03:10;
 CPT Changes: An Insider's View 2011

▶(11040, 11041 have been deleted)◀

11040 Debridement, skin, partial thickness
 ↻ CPT Assistant Fall 1993:21, May 1996:6, Feb

11041 skin, full thickness
 ↻ CPT Assistant Fall 1993:21, May 1996:6



▶(For debridement of skin, ie, epidermis and/or dermis only, see 97597, 97598)◀

▶(For active wound care management, see 97597, 97598)◀

Active Wound Care Management

Active wound care procedures are performed to remove devitalized and/or necrotic tissue and promote healing. Provider is required to have direct (one-on-one) patient contact.

▶(Do not report 97597-97602 in conjunction with 11042-11047 for the same wound)◀

▶(For debridement of burn wounds, see 16020-16030)◀

▲ **97597** Debridement (eg, high pressure waterjet with/without suction, sharp selective debridement with scissors, scalpel and forceps), open wound, (eg, fibrin, devitalized epidermis and/or dermis, exudate, debris, biofilm), including topical application(s), wound assessment, use of a whirlpool, when performed and instruction(s) for ongoing care, per session, total wound(s) surface area; first 20 sq cm or less
 ↻ CPT Assistant Jun 05:1, 10, Nov 09:10; CPT Changes: An Insider's View 2005, 2011

+▲ **97598** each additional 20 sq cm, or part thereof (List separately in addition to code for primary procedure)
 ↻ CPT Assistant Jun 05:1, 10; CPT Changes: An Insider's View 2005, 2011

▶(Use 97598 in conjunction with 97597)◀

11042

- From “Debridement, skin, and subcutaneous tissue”
- to
- Debridement, subcutaneous tissue (includes epidermis and dermis, if performed); first 20 sq cm or less



11045

- Add on code for 11042
- Debridement, subcutaneous tissue (includes epidermis and dermis, if performed); each additional 20 sq cm, or part thereof (List separately in addition to code for primary procedure)
- Use 11045 in conjunction with 11042



= Resequenced code

- ▲ **11042** Debridement, subcutaneous tissue (includes epidermis and dermis, if performed); first 20 sq cm or less
⌚ CPT Assistant Winter 92-10, May 96-6, Feb 97-7, Aug 97-6, Jun 05-1, 10, Oct 07-15; CPT Changes: An Insider's View 2011
▶(For debridement of skin [ie, epidermis and/or dermis only], see 97597, 97598)◀
- #+● **11045** each additional 20 sq cm, or part thereof (List separately in addition to code for primary procedure)
⌚ CPT Changes: An Insider's View 2011
▶(Use 11045 in conjunction with 11042)◀
- ▲ **11043** Debridement, muscle and/or fascia (includes epidermis, dermis, and subcutaneous tissue, if performed); first 20 sq cm or less
⌚ CPT Assistant May 96-6, Feb 97-7, Apr 97-11, Aug 97-6, Dec 99-10, Jun 05-1, 10, Oct 07-15; CPT Changes: An Insider's View 2011



To accommodate revised 11043 and new 11046 ☺

- 11043 Debridement, muscle and/or fascia (includes epidermis, dermis, and subcutaneous tissue, if performed); first 20 sq cm or less
- 11046 each additional 20 sq cm, or part thereof (List separately in addition to code for primary procedure)



Dizzying Diversion : Appendix N— Summary of Resequenced CPT Codes

- Rather than deleting and renumbering, resequencing allows existing codes to be relocated to an appropriate location for the code concept, regardless of the numeric sequence.
- The codes listed are identified in CPT 2011 with a # symbol for location of the resequenced number within the family of related concepts.



Appendix N—Summary of Resequenced CPT Codes

- Numerically placed references (eg, Code is out of numerical sequence. See...) are used as navigational alerts to direct the user to the location of the out-of-sequence code.



Trivial Pursuit

11045 11046 11047 21552 21554
23071 23073 24071 24073 25071
25073 26111 26113 27043 27045
27059 27329 27337 27339 27632
27634 28039 28041 29914 29915
29916 46220 46320 46945 46946
46947 51797 80104 82652 87906
88177 90665 95800 95801 99224
99225 99226 0253T



Reminder: Measuring and Coding the Removal of a Lesion

Measuring lesion removal.

A. Example: excision, malignant lesion of the back, 1.0 cm. Code 11606.

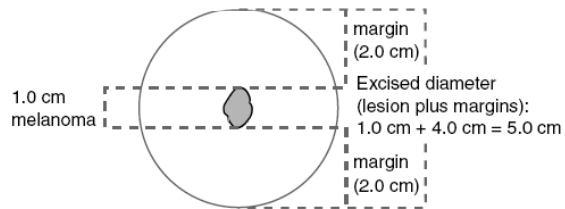

B. Example: Excision of benign lesion of the neck, 1.0 cm by 2.0 cm. Code 11423.

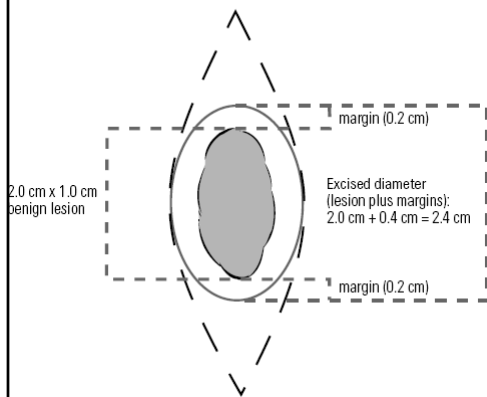

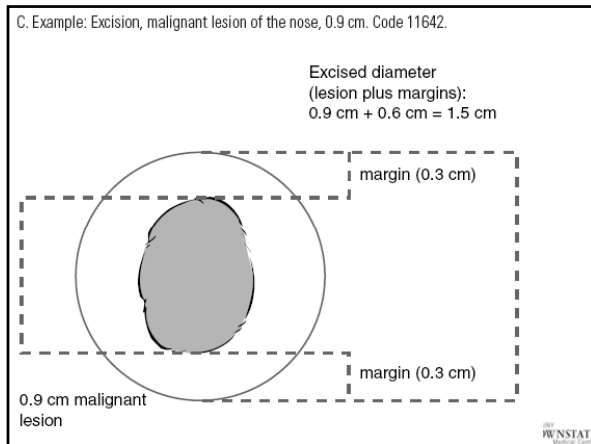

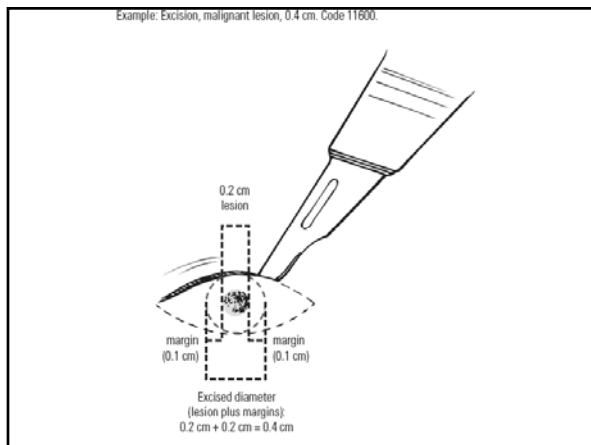

Re-excision of malignant lesions

- During same operative session, add the initial excision (1.0 cm) with narrowest margins (0.3 cm x 2) plus the re-excision margins (0.3 cm x 2) to final excised lesion of 2.2 cm. Bill only one procedural code.
- Subsequent visit: initial excision is 1.6 cm and the re-excision is 0.6 cm.
- A repair (1204x) may be needed after the lesion re-excision, billed by length of repair 2.2 cm

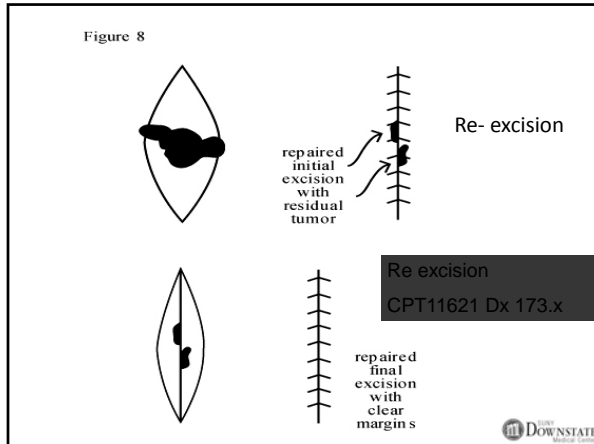

Back to the future... more CPT 2011 changes!



- Complex repair includes the repair of wounds requiring more than layered closure, viz., scar revision, debridement (eg, traumatic lacerations or avulsions), extensive undermining, stents or retention sutures. Necessary preparation includes creation of a limited defect for repairs or the debridement of complicated lacerations or avulsions. Complex repair does not include excision of benign (11400-11446) or malignant (11600-11646) lesions, excisional preparation of a wound bed (15002-15005) or debridement of an open fracture or open dislocation.

Complex Repair Comments

- Should not change utilization by us.
- Some think we overuse these in general.
- We are the major users of many of these codes.
- We perform almost 2/3 of truncal complex closures of 1.1 to 2.5 cm.
- We perform almost ¾ of truncal complex closures of 2.6-7.5 cm

☺ You Are On Candid Camera

- CMS will still recognize/pay for Telehealth consultations.
- But don't smile yet.
- Only live interactive.
- Not store-forward yet as
- that would only increase utilization.
- We are at war (Iraq-Afghanistan-Taliban-Senate – House -Trial Lawyers) !



Flaps - Reminder

- Codes 14000-14302
- Undermining alone of adjacent tissues to achieve closure, without additional incisions, does not constitute adjacent tissue transfer.

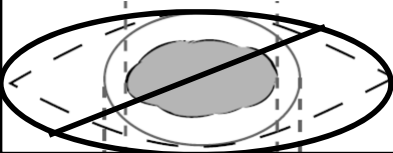

2010 Flipping on Flaps

14300 - Adjacent tissue transfer or rearrangement, more than 30 sq cm, unusual or complicated, any area.



2010 Kids on the Block

- 14301 - Adjacent tissue transfer or rearrangement, any area, 30.1 sq cm to 60.0 sq cm.
- 14302 – each additional 30.1 sq cm or part thereof (List seperately in addition to code for primary procedure)



Island pedicle Flap - NOT

- Can you spot the other change in the introductory 14xxx directives:
- OLD: (eg, Z-plasty, W-plasty, V-Y plasty, rotation flap, advancement flap, double pedicle flap).
- NEW: (eg, Z-plasty, W-plasty, V-Y plasty, rotation flap, random island flap, advancement flap, ~~double pedicle flap~~).



Island pedicle & neurovascular pedicle flaps.

- 15740 Flap, island pedicle
- 15750 Flap, neurovascular pedicle
- Same words but different meaning.
- No longer what we though they meant.
- No longer what literature has used to describe them.
- Instead.....



Δs in Attitude, Δs in Latitude

- Code 15740 describes a cutaneous flap, transposed into a nearby but not immediately adjacent defect, with a pedicle that incorporates an axial vessel into it's design. The flap is typically transferred through a tunnel underneath the skin and sutured into its new position. The donor site is closed directly.



Δs in Attitude, Δs in Latitude

- Neurovascular pedicle procedures are reported with 15750. This code includes not only skin but also a functional motor or sensory nerve(s). The flap serves to reinnervate a damaged portion of the body dependent on touch or movement (e.g. thumb).



Skin Replacement Surgery and Skin Substitutes

- Codes 15002-15005 describe the services related to preparing a clean and viable wound surface for placement of a graft, flap, skin replacement, skin substitute or negative pressure wound therapy. In some cases, closure may be possible using adjacent tissue transfer (14000- 14061) or complex repair (13100-13153).
- In English, not all 15002-5 have to be grafted?



Skin Replacement Surgery and Skin Substitutes

- Do not report 15002-15005 for removal of nonviable tissue/debris in a chronic wound (eg, venous or diabetic) when the wound is left to heal by secondary intention. See active wound management codes (97597-97598) and debridement codes (11042- 11047) for this service. For necrotizing soft tissue infections in specific locations, see 11004-11008.
- NOT DEBRIDEMENT CODES. Semantics?



Skin Replacement Surgery and Skin Substitutes

- Do not report 15002-15005 in conjunction with 15340-15341. (15340 /1 are for tissue cultured allogeneic skin substitute) which include wound prep by CPT definition.
- I did not make these rules up and their explanation is outside our allotted time.



The screenshot shows the HealthData Management website interface. At the top, there is a search bar and navigation links. The main content area features an article titled "Senate OKs Exemptions to Red Flags Rule" dated December 2, 2010. The article text discusses the Senate's approval of a bill (S. 3687) that exempts certain financial institutions from the Red Flags Rule. A sidebar on the right contains social media sharing options (Print, Email, Facebook, Twitter, LinkedIn, Dribbble, RSS) and a "Share" button. At the bottom of the article, there is an advertisement for "patientkeeper Reinventing CPOE" with a "Learn More" link.

Red Flags Rule

- The rule requires businesses to take specific steps to minimize identity theft.
- Compliance date for the rule has been extended several times as various industries contest their inclusion.
- Several medical associations previously filed a lawsuit to prevent the Federal Trade Commission from extending the rule to physicians.



Exemptions to Red Flags Rule

- S. 3987 introduced and approved by unanimous consent on Nov. 30.
- Referred to the House Committee on Financial Services.
- It exempts providers and others who permit payment to be deferred.
- “Doctors and lawyers” to quote Willie Nelson.
- House previously passed similar legislation.
- Must approve S. 3987 during lame duck session or the bill must be reintroduced in 2011.



S. 3987: Red Flag Program Clarification Act of 2010

Overview

Sponsor: Sen. John Thune (R-SD) [View Cosponsors \(1\)](#)

Text: [Full Text](#)

Status:

- Introduced: Nov 29, 2010
- Referred to Committee: View Committee Assignments: Nov 29, 2010
- Passed Senate: Nov 30, 2010
- House Title: --
- Signed by President: --

Last Action: Dec 1, 2010: Referred to the House Committee on Financial Services.

Related: See the [Related Legislation](#) page for other bills related to this one and a list of subject terms that have been applied to this bill. Sometimes the text of one bill or resolution is incorporated into another, used in their...

Sustainable Growth Rate (SGR) Medicare Physician Payment

- Congress passed 30 day freeze (at current level) at end of November.
- **Medicare physician payment now scheduled to be cut 25% on January 1, 2011.**
- Currently, Congress is negotiating a 12 month fix that would provide a freeze (at current level) until December 31, 2011
 - Cost and how to “pay for” the bill are the biggest sticking points.
 - Cost of 12 month fix \$14-15 billion



CMS 2011 Physician Fee Schedule

- CMS posted on November 2, 2011
- Accepting comments through January 3, 2011
- Good news/bad news



Medicare & Medicaid Extenders Act of 2010 (MMEA)

**12/15/10 – President Obama signed
Zero Percent Increase
Jan 1 thru Dec 31, 2011
Budget Neutral
Revised Conversion Factor = \$33.9764**



**Increase in PE Indirect Inputs
for Dermatology**

- Dermatologists responded to:
 - 2009 AMA Physician Practice Information Survey (PPIS)
 - 2004 AAD Supplemental PE Survey
- 2011 Medicare Fee Schedule calculations increase Derm Indirect PE/Hr
 - from \$158.49 (AAD 2004 PE data)
 - to \$184.62 (AMA 2009 PE data).



Conversion Factors

2010 Conversion Factor = \$36.8729

CMS 2011 Conversion Factor = \$28.3868

MMEA 2011 Conversion Factor = \$33.9764

-8 percent for CY 2011

Negative - \$2.90 / RVU

**CMS 2011 Physician Fee Schedule
(Cont.)**

- Good news
 - Completing transition of PE values based on AMA PPIS Survey
 - Indirect PE value for derm increase from \$152/hr to \$182/hr. Reflected in PE RVUs for dermatology procedures.
 - Net impact to dermatology +3% due to the PE transition and the rebasing of the MEI
- A bigger piece of a shrinking pie.
 - So no whining to your FP/IM/GI/etc friends.
 - They already hate you.



CMS 2011 Action Plan

- Dermatology codes to be reviewed
 - Multiple Points of Comparison list: the reference bible.
 - 17000 and 11100
 - Low Work RVUs billed in multiple units: 17003 and 11101
- Will be added to RUC agenda, require survey data to support values or possibly re-valued



Additional Code Review

- September RUC meeting: 39 codes reviewed
- New Subcommittee held kickoff meeting
- Codes reviewed in September included intermediate repair, complex repair, full thickness skin graft, malignant destruction, and eyelid biopsy.
- Results are embargoed until 2012 fee schedule.
-



Relativity Assessment Workgroup

- Formerly the 5 Year Review process.
- Now a “rolling” the 5 Year Review to clip more wings more often.
- New Technology/New Services List
- MPC Codes.
- Low Value/Billed in Multiple Units
- Low Value/High Volume Codes
- Site of Service Anomalies



Medicare Participation Options

- Change PAR/NONPAR status by December 31, 2010
 - Notify contractor in written form postmarked on or before 12/31/10
- Considerations:
 - Medicare payment rates
 - Contractual obligations (hospitals, health plans, others requiring PAR status)
 - Participation incentives
- More information at www.aad.org/pm/billing/medicare/



Where is Health System Reform Now?

- Huge Republican Gains in 2010 Midterm Elections
- HSR Played a Role in Democrats' Defeat
 - Moderate Democrats lose big
- Legislative Options
 - Repeal and Replace
 - Defunding
 - Other Changes



Health System Reform Physician Impact

- *Accelerated Use of Quality Measures*
 - Behavioral change techniques are not just the federal government's idea; private insurance has been leading the charge on many of them, even before the new law was passed.
- *Physician Compare Website - 2013*
 - Public reporting of physician quality and efficiency measures and patient satisfaction
- *From Voluntary to Mandatory - 2015*
 - Medicare 1.5% Penalty for non-reporting begins and Cantwell cost/quality value index implementation



Health System Reform Physician Impact

- Quality measurement is here to stay right now.
- Costs continue to skyrocket.
- Efforts will be made to understand if the use of data to measure a physician’s “quality” and efficiency” can help control cost growth.



Health System Reform Physician Impact

- AADA’s main points of contention with the legislation: there is not enough “clinically robust data” available to accurately measure a physician’s quality and cost efficiency.
- Until such time that data becomes available, Medicare claims data will serve as one of the largest sources of data, which is a problem because claims data cannot be risk-adjusted enough to provide an accurate a complete picture.



Physician Impact Cost Control – The IPAB

- Establishes 15 member Independent Payment Advisory Board (IPAB) to submit annual proposals beginning 2014 to extend solvency and improve quality
 - physicians, other health professionals, economists, PBMs, employers, payers, HSR, tech assessment, consumer groups, elderly, facility management, insurers



**Physician Impact
Cost Control – The IPAB**

- Annual proposals to meet target reductions in per-capita cost (relative to inflation) beginning 2015
- If Congress doesn't pass, HHS must implement
- If Congress wants to amend, must come up with same amount of savings
- Prohibited from rationing care or changing benefits
- Hospitals & Hospices Exempt until 2020!!!



Cost control is coming...

- Fee for Service is viewed as a broken model
- Likely to be part of a matrix of payment options in the future, but no longer the predominate form of paying physicians
- No easy single target...



Cost control is coming...

- Effort to drive physicians into Accountable Care Organizations (ACOs), a concept that seeks more integrate care among physicians.
- Remember gatekeepers, capitation, medical home.....



Cost control is coming...

- Right now, ACOs are conceptual in nature, but we will see broad regulations within the next few months that will begin to define how such entities would operate around the country.
- The AADA understands the serious nature of this issue and is actively engaged at every possible level to ensure that dermatologists are protected and have the ability to treat their patients.



Payment and Delivery Reform

- CMS Center for Innovation
 - <http://www.innovations.cms.gov/>
 - Bundled payments
 - Physician episodes of care
 - Accountable Care Organizations (shared savings programs)
 - Capitation
 - Medical Home pilots
- Voluntary for now... IPAB can change that

No Illusions About Friends Dermatology at Risk

- Dermatologists are 1% of physicians and get 3% of Medicare expenditures
- Skin cancer is #16 most costly Medicare diagnosis



Annual Change in Frequency per Medicare Enrollee 2007-2008

Average growth	17311 (Mohs)	10%
3% growth for a physician service/code in 2007-2008	11100 (Skin Biopsy)	10%
	88305 (Pathology)	9%
	17000 (Destruction)	6%

- **Attributable to skin cancer epidemic?**
This has been happening for a few years now. The percentage growth is simply too high to be explained away completely.

AADA's Strategy

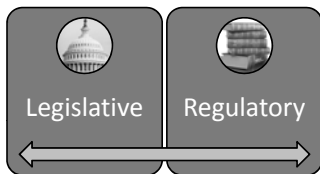

1. Pursue all opportunities to impact the law.
2. Active during implementation, not just towing the line.
3. Analyze future legislative efforts to enact change.



Health System Reform Resource Center



Visit www.aad.org/hsr regularly to get up-to-date information.

Important Advocacy Websites

- Government Affairs
 - www.aad.org/gov
- Health System Reform Resource Center
 - www.aad.org/hsr
- SkinPAC
 - www.skinpac.org
- Grassroots Advocacy
 - www.aad.org/dan

Coding Soup for Dermatology

 *American Academy of Dermatology Association*
Physicians Dedicated to Excellence in Dermatology™

Coding Soup for Dermatology

Daniel Siegel, MD, FAAD
Faith McNicholas
Peggy Eiden
January 20, 2011
Chicago Dermatological Society

1

Physicians exempt

- Dec, 2010 Congress approved Physicians are no longer considered “creditors” in Red Flag Rule
- Good compliance - continue to review patient’s ID



2

 *American Academy of Dermatology*
Physicians Dedicated to Excellence in Dermatology™

Medicare eligibility?

- Ask for Medicare Insurance Card
 - Name, sex, & effective date Part B
 - Health Insurance claim number (HICN)
- Make a photocopy
 - Confirm info with photo ID
- Re-check it at least once per year

 *American Academy of Dermatology*
Physicians Dedicated to Excellence in Dermatology™

OIG 2011 Work Plan

- Medicare Secondary Payer/Other Insurance Coverage
Review beneficiaries claims for third party payers
- Place of Service Errors
- Coding of E/M Services
- Payments for E/M Services
- E/M Services During Global Surgery Periods
- Medicare Providers' Compliance With Assignment Rules
- Medicare Payments for Claims Deemed Not Reasonable and Necessary
- Medicare Billings With Modifier GY

 American Academy of Dermatology

NEW Signature Requirements

- CERT error rate up to 8%
- Legible Identifier is **IMPORTANT!**
- hand written or
- an electronic signature
- (stamp signatures are not acceptable)
- For all orders, scripts or other medical record documentation

CMS, Internet Only Manual, Publication 100-8, Ch 3, Section 3.4.1.1 B

 American Academy of Dermatology

Accepted format

- Full legible signature – first & last
- Legible initial with last name
- Illegible signature
 - on identified letterhead
 - over typed/printed name
 - with a Key, Log, or attestation
- Don't use "signature on" file or a stamp

 American Academy of Dermatology

Who still pays for consults?

Payer	Status	Effective date
Aetna	Accepts Consult codes	
Anthem – Commerical	Accepts Consult codes	
Anthem-Medicare	Doesn't accept Consult codes	1/1/10
Cigna	Accepts Consult codes	
Humana-Commerical	Accepts Consult code	
Humana-Medicare	Doesn't accept Consult codes	1/1/10
United Healthcare-Commerical	Accepts Consult codes	
United Healthcare-Medicare	Doesn't accept Consult codes	1/1/10

7

AAD American Academy of Dermatology and AAD Association
Physicians Dedicated to Excellence in Dermatology

Consultations reminder...

R – reason
R – request
R – render
R – report

8

AAD American Academy of Dermatology
Physicians Dedicated to Excellence in Dermatology

Hospital & SNF services without consults codes

- Initial hospital visit no longer restricted to admitting physician, more that one initial hospital visit per hospital stay allowed
- Consulting physician may report initial hospital care codes (99221-99223) or Nursing Home codes (99307-99310)
- Admitting physician must report a modifier
– Modifier **AI** is informational

9

AAD American Academy of Dermatology
Physicians Dedicated to Excellence in Dermatology

Comparing E/M Components Hospital & SNF				
Consult Code	New Patient Code	History	Exam	MDM
99251 20 mins	99231 15 mins 99307	Problem Focus	Problem Focus	Straightfwd or Low
99252 30 mins	99232 25 mins 99308	Exp Problem Focus	Exp Problem Focus	Moderate
99253 55 mins	99221 30 mins	Detailed	Detailed	Straightfwd or Low
99254 80 mins	99222 50 mins	Comprehensive	Comprehensive	Moderate
99255 110 mins	99223 70 mins	Comprehensive	Comprehensive	High

**& Office/Outpatient Services
(99201-99205 or 99211-99215)**

- These codes should be used as appropriate to the patient status in place of the outpatient consultation codes
- If patient is seen by MD or group in the last 3 years, must be billed as an established patient office visit (99211-99215)
- Emergency Dept codes 99281-99285 unless patient is admitted
- What does a subspecialist in the same group report?

11

 American Academy of Dermatology

Physicians in Group Practice

- CMS manual 30.6.5
- Same
 - Group
 - Specialty
 - Paid as single physician even if more than one E/M provided
 - Report only one combined E/M
 - Unless unrelated problem

12

 American Academy of Dermatology

http://www.cms.hhs.gov/MLNEdWebGuide/25_EMDOC.asp

Documentation Help

- CMS' E/M '95 & '97 Documentation Guidelines

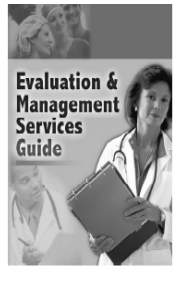

Evaluation & Management Services Guide

AAAD American Academy of Dermatology

E/M Documentation Components

Key Components

- History
- Examination
- Medical Decision Making

Contributory Components

- Counseling
- Coordination of Care
- Nature of Presenting Problem
- Time

AAAD American Academy of Dermatology

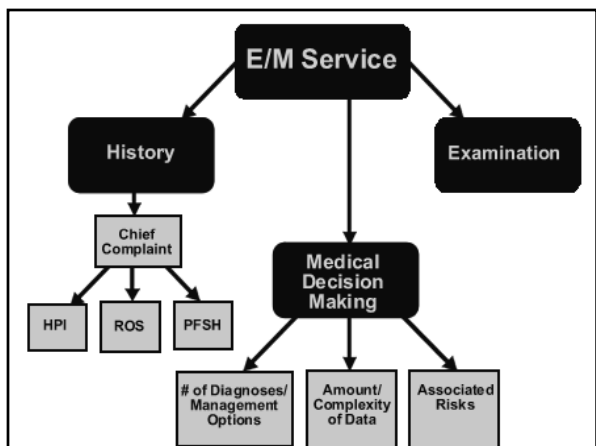

E/M History Elements

- **Chief Complaint (CC)** –
A concise reason for the visit.
- **History of Present Illness (HPI)** -
Patient's own description of the problem
- **Review of Systems (ROS)** –
Doctor's question list of patient's experienced symptoms
- **Past Family Social History (PFSH)** –
Pertinent history that may contribute to the present illness

AAAD American Academy of Dermatology

Chief Complaint (CC)

- Examples of Incomplete CC:
 - Recheck
 - Follow up
- Use descriptive language:
 - Recheck for chronic condition...
 - F/U for ...
 - Annual skin exam - hx of...

AAAD American Academy of Dermatology

Can we ever bill 99204?

- Ex: if a new pt comes in for a full skin exam and other complaints such as acne and eczema and hair loss = 99204?
- Comprehensive History & Exam; Moderate Medical Decision Making
- If medically necessary – **MAYBE – BUT**
- **'95 – CPT 7 body areas - gray**
- **'97 – CMS 28 bullets – bullet proof**



AAAD American Academy of Dermatology Association

CLIA – PPMP is needed

- CLIA Certificate of Provider-performed Microscopy Procedures (PPMP) is required for provider-performed microscopy procedures:
- Q0111 Wet mounts, including preparations of vaginal, cervical or skin specimens
- Q0112 All potassium hydroxide (KOH) preparations

19

AAD American Academy of Dermatology Association

CDS

- When should we bill for shave removal versus biopsy?
- Excellent article in ***DermCoding Consult***, Summer 2008 prepared by James A Zalla, MD FAAD

20

AAD American Academy of Dermatology Association

can we bill 99203?

- If a new pt comes in for acne and we initiate accutane after talking with them for over 30 minutes,
- Face to Face visit with more that 50% of the time counseling the patient with documentation on the subject.
- **Maybe with at least a detailed HX & Exam & MDM of low complexity**

21

AAD American Academy of Dermatology Association

CDS

- Are there requirements to bill for an excision?
- AMA/CPT definition –
- Excision is defined as full thickness (through the dermis) removal of a lesion, including margins and includes a simple (non layered repair)

22

AAAD American Academy of Dermatology Association

Acne

- 10040 – Acne surgery
- 17340 – Cryotherapy for acne
- E/M for Accutane therapy
 - Use time counseling component
- 17999 – Unlisted procedure, skin, mucous membrane & subcutaneous tissue
- (Use for Blue light Tx for Acne)
- 10 day global - DX: 706.1

AAAD American Academy of Dermatology Association

CDS Acne

- 10040 - do's and don'ts of billing for acne surgery/comedone extraction

Check with private payors

AAAD American Academy of Dermatology Association

CDS

- IF we do a shave removal of a pigmented lesion with 1-2mm margins and go deep enough to see fat globules, can we bill an excision?
- CMS & CPT state the most definitive procedure is to be reported
- **If the procedure goes thru the dermis - MAYBE – Dr Siegel?**

25

AAAD American Academy of Dermatology Association

Globals modifiers- 54 & 55

- We have a Mohs surgeon in our office and she feels can charge office charge for patients we send to her. We are having a problem getting paid for Medicare on follow-ups by general derm in post-op of Mohs repair even when add modifier and send chart notes. Is an office charge appropriate?
- 54 – Surgical care only
- 55 – Post op care
- http://www.wpsmedicare.com/part_b/education/modifiers.shtml

26

AAAD American Academy of Dermatology Association

Screening diagnosis

- How does one code and bill for procedures or tests for which a condition is being ruled out or has not yet been diagnosed or turns out to be negative?
- Check CMS' Clinical Lab NDC <http://www.cms.gov/center/clinical.asp> under Coverage 4th bullet
- Try sign or symptom diagnosis
- Don't report diagnoses PT doesn't have!

27

AAAD American Academy of Dermatology Association

Cosmetic vs Medical Necessity?

- Our practice struggles with the correct way to bill removal of milia. Acne Surgery - 10040 versus Destruction - 17110 codes, please clarify which is the correct way to bill for milia removal. Medicare and others deny payment for 10040 with a dx of 706.2 for removal of milia
- AMA/CPT states 10040

Surgical trays

- Is it appropriate to bill for different types of trays? i.e. biopsy tray, excision tray, I & D tray.
 - Maybe NOT as it's included in the procedure RVU Practice Expense
- Do most Derm practices bill for surgical trays?
 - Don't know

Check Payers Medical Policies

- Our practice takes medical photos is there a code or way to bill for medical photos?
 - Yes – 96904 Whole body photography
- Does a patient need at least 10 lesions before qualifying for PDT. This seems to be a Blue Cross Blue Shield policy? Do you have any add'l information regarding the number of lesions?
 - No, it's a cost issue of Levulan

What would your do?

- New patient referred to us by PCP; removal of BCC was done by PCP but further excision was needed. Dr. did further excision; biopsy result came back as scar- not a covered diagnosis. Sent in an appeal with records and letter explaining, but was still denied by Medicare. How would you present this in order to get the claim paid?

31

AAAD American Academy of Dermatology Association

Billing Skin Screenings

- Sound medical advise
 - usually non covered
- Skin screening not a CMS preventive visit or covered benefit
- use 992xx E/M with V-code
 - don't use 993xx Preventive
- **screen patient for chief complaint**

AAAD American Academy of Dermatology Association

What auditors look for?

- Organized medical record
- Dated documentation filed in chart
- Legible handwriting
- *CERT issue - All entries signed/initialed and dated by provider & staff
 - Reviewed history: ROS & PFSH
 - Including X-ray, Path & Lab reports
- Key documentation components of Evaluation and Management (E/M)

AAAD American Academy of Dermatology

E/M Baseline Assessment

AAD's AUDIT SURVIVAL TOOLKIT

- Identify compliance issues
 - Identify revenue opportunities
- Random sample for each provider
 - Focus reviews

Visit AAD's website for the free version!
http://www.aad.org/pm/billing/coding/_do_c/AADAuditSurvivalToolkit.pdf

AAD American Academy of Dermatology

2011 Deleted CPT codes

(11040, 11041 have been deleted)

~~11040~~ - Debridement; skin partial thickness
~~11041~~ – Debridement; skin full thickness

(For debridement of skin, ie, epidermis and/or dermis only, see 97597, 97598)
 (For active wound care management, see 97597, 97598)
 (For debridement of burn wounds, see 16020-16030)

AAD American Academy of Dermatology and AAD Association

2011 CPT cont...

▲ 11042 Debridement, subcutaneous tissue (includes epidermis and dermis, if performed); first 20 sq cm or less
 (For debridement of skin [ie, epidermis and/or dermis only], see 97597, 97598)

#+● 11045 each additional 20 sq cm, or part thereof (List separately in addition to code for primary procedure)
 (Use 11045 in conjunction with 11042)

AAD American Academy of Dermatology and AAD Association

Active wound care

- ▲ 97597 Debridement (eg, high pressure water jet with/without suction, sharp selective debridement with scissors, scalpel and forceps), open wound, (eg, fibrin, devitalized epidermis and/or dermis, exudates, debris, biofilm) including topical application(s), wound assessment, use of a whirlpool, when performed and instruction(s) for ongoing care, per session, total wound(s) surface area; first 20 sq cm or less
- ▲+97598 each add'l 20 sq cm or part thereof

AAD American Academy of Dermatology and AAD Association
Physicians Dedicated to Excellence in Dermatology

Active wound care 97597, 97598

- Coverage found in Physical Therapy LCD
- AWC debridement usually indicated for necrotic tissue present on a open wound
- Conservative sharp debridement for minor procedure w/little bleeding
- Treatment plan
- Need to show improvement
- Physicians vs Non physicians

AAD American Academy of Dermatology and AAD Association
Physicians Dedicated to Excellence in Dermatology

Dermopathology new for 2011...

88329 Pathology consultation during surgery:

- 88330 first tissue block, w/frozen section(s); single specimen
- + ▲ 88332 each additional tissue block with frozen section (List separately in addition to code for primary procedure)

39

AAD American Academy of Dermatology
Physicians Dedicated to Excellence in Dermatology

2011 Modifier update

50 - Bilateral Procedure:

- Unless otherwise identified in the listings, bilateral procedures that are performed at the same ~~operative~~ session, should be identified by adding modifier 50 to the appropriate 5 digit CPT code.
- 29590/50 = 2 procedures. Report 150% fee

 American Academy of Dermatology

Modifier 78

Unplanned Return to the Operating/Procedure Room by the Same Physician or Other Qualified Health Care Professional Following Initial Procedure for a Related Procedure During the Postoperative Period:

It may be necessary to indicate that another procedure was performed during the postoperative period of the initial procedure (unplanned procedure following initial procedure). When this procedure is related to the first, and requires the use of an operating/procedure room, it may be reported by adding modifier 78 to the related procedure. (For repeat procedures, see modifier 76.)

 American Academy of Dermatology

Modifier 76

Repeat Procedure or Service by Same Physician or Other Qualified Health Care Professional:

It may be necessary to indicate that a procedure or service was repeated by the same physician or other qualified healthcare professional subsequent to the original procedure or service. This circumstance may be reported by adding modifier 76 to the repeated procedure or service.

Note: This modifier should not be appended to an E/M service.

 American Academy of Dermatology

2011 ICD9 Codes

Limited codes for Dermatology

- 237.73 Schwannomatosis
- 237.79 Other neurofibromatosis
- 287.41 Posttransfusion purpura
- 287.49 Other secondary thrombocytopenia
- 488.xx Flu different conditions

 American Academy of Dermatology
Copyright © 2011 American Academy of Dermatology. All rights reserved.

ICD-10-CM

- What is ICD-10-CM
- Why is ICD-9-CM being replaced
- What is the Value of ICD-10-CM
- Understanding ICD-10-CM
- Preparation & Implementation of ICD-10-CM



 American Academy of Dermatology
Copyright © 2011 American Academy of Dermatology. All rights reserved.

Date	Compliance Step
January 1, 2010	Payers/providers begin internal testing of Version 5010 standards for electronic claims
December 31, 2010	Internal testing of Version 5010 must be complete to achieve Level I Version 5010 compliance
January 1, 2011	<ul style="list-style-type: none"> ✓ Payers/providers begin external testing of Version 5010 for electronic claims ✓ CMS begins accepting Version 5010 claims ✓ Version 4010 claims continue to be accepted
December 31, 2011	External testing of Version 5010 for electronic claims must be complete to achieve Level II Version 5010 compliance
January 1, 2012	<ul style="list-style-type: none"> ✓ All electronic claims must use Version 5010 ✓ Version 4010 claims are no longer accepted
October 1, 2013	<ul style="list-style-type: none"> ✓ Claims for services provided on or after this date must use ICD-10 codes for medical diagnosis and inpatient procedures ✓ CPT codes will continue to be used for outpatient services

ICD-9 Overview

ICD-9 was implemented in the U.S. in 1979

- Many limitations of ICD-9
 - 30 years old
 - Many sections are full, impeding expansion
 - Not descriptive enough
 - Not able to accurately reflect advances in medical knowledge or technology
 - Will not meet health care needs of the future

 American Academy of Dermatology

What is ICD-10- CM?

- ✓ International Statistical Classification of Diseases and Related Health Problems - 10th Revision
- ✓ Alphanumeric statistical system for coding every disease, description of symptom, abnormal finding, complaint, social circumstance, external cause and cause of injury, disease or death afflicting human beings, **as classified by the World Health Organization**

 American Academy of Dermatology

Why is ICD-9-CM being replaced?

- ✓ No longer fits 21st century healthcare system
- ✓ Hampers the ability to compare costs and outcomes
- ✓ Running out of capacity
- ✓ Obsolete, no longer reflects current disease processes

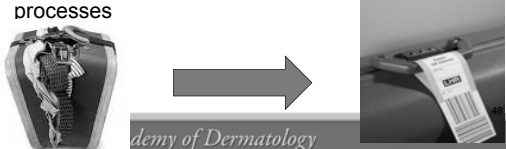

 demy of Dermatology

D04 Carcinoma in situ of skin
D04.0 Carcinoma in situ of skin of lip
 excludes 1: carcinoma in situ of vermilion border of lip (D00.01)
D04.10 Carcinoma in situ of skin of eyelid, including canthus, unspec side
D04.11 Carcinoma in situ of skin of right eyelid, including canthus
D04.12 Carcinoma in situ of skin of left eyelid, including canthus

2011: Time to Get Ready

To Do List: Understand

- ✓ ICD-10-CM final rule
- ✓ implications pertaining to your role in the process and coding as a whole
- ✓ documentation requirements

Visit the CMS website and AAD website for up-to-date information
<http://www.cdc.gov/nchs/icd/icd10cm.htm>



50

AAD American Academy of Dermatology

2011: Time to Get Ready – Phase 1

➤ **Impact Assessment**

- ✓ Impact of change to new coding system
- ✓ Identify key tasks and objectives
- ✓ Create implementation planning team
- ✓ Budget for required Information System (IS)
- ✓ Education

51

AAD American Academy of Dermatology

Time to Get Ready cont...

- ✓ Use assessment tools to identify areas of strength/weakness in the biomedical sciences (e.g. anatomy and pathophysiology)
- ✓ AHIMA
 - <https://www.ahimastore.org/ProductDetailEAssessments.aspx?ProductID=13258%20>
- ✓ AAPC
 - <http://www.aapc.com/ICD-10/implementation-training.aspx>
- ✓ Review and refresh knowledge of biomedical concepts as needed based on the assessment results

52

 *American Academy of Dermatology*

Time to Get Ready cont...

- ✓ Begin learning about the general equivalence mappings (GEMs) between ICD-9-CM and ICD-10-CM
- ✓ Identify budgetary implications – hardware & software upgrades
- ✓ Identify which areas and how much time you will need for training

53

 *American Academy of Dermatology*

Plan ICD-10 Training

- Begin training approximately 6 months prior to implementation
 - ✓ Training too early will be of little benefit
 - ✓ Use it or lose it!
- ICD-10 proficiency estimated to occur within the first 6 months
 - ✓ Coding professional education and experience may increase or decrease this estimation

54

 *American Academy of Dermatology*

October 01, 2013- FIRM

- Single compliance date will be enforced for payers and providers beginning October 01, 2013
- Code from the appropriate ICD version according to date of service
 - ✓ Outpatient dates of service are determined by the actual date of service
 - ✓ Inpatient dates of service are determined by discharge
- ❖ **Must use code set that is valid at the time of service**

55

 American Academy of Dermatology

In Summation

- Assess 5010 transaction standards readiness
- Inventory processes and systems that will be impacted
- Plan for staff training
- Conduct staff gap analysis of coding knowledge
- Develop a budget

56

 American Academy of Dermatology

'Incident to' Medicare term

- Supervising Physician **must be in office suite & available to direct**
- Established treatment plan
- PA/NP's services provided as ancillary personnel **under** direct physician supervision, services may be covered as "incident to" services
- Supervision continuous but physical presence of physician **not** required at all times

57

 American Academy of Dermatology

The 2011 Physician Quality Reporting System

- **New program name this year!**
- Participants choose from two reporting periods:
 - January 1 – December 31, 2011 (12 months)
 - Bigger check, more work
 - July 1 – December 31, 2011 (6 months)
 - Smaller check, less work
- Participants are eligible to receive **1%** of total allowed Medicare Part B charges for the chosen reporting period
- Participants must report on at least three individual quality measures in order to qualify for the incentive

 American Academy of Dermatology
Physicians' National Self-Assessment for Performance

Changes for 2011

Measure #136 will *not* be available for reporting in 2011

#136

- **Melanoma: Follow-up**
- Percentage of patients with a new melanoma or a history of melanoma who received the following aspects of care within 12 months of diagnosis: AND (1) a complete physical skin exam was performed specifically if he/she had any new or changing moles; AND (2) a complete physical skin exam was performed and the morphology, size, and location of new or changing moles was documented; AND (3) patient was counseled to perform a monthly self skin exam.

 American Academy of Dermatology
Physicians' National Self-Assessment for Performance

2011 Dermatology Measures (Registry Only Submission)

#137

- **Melanoma: Continuity of Care-Recall System**
- Percentage of patients with a new melanoma or a history of melanoma whose information was entered, at least once within a 12 month period, into a recall system that includes:
 - A target date for the next complete physical skin exam, AND
 - A process to follow up with patients who either did not make an appointment within the specified timeframe or who missed a scheduled appointment

#138

- **Melanoma: Coordination of Care**
- Percentage of patient visits with a new melanoma who have a treatment plan documented in the chart that was communicated to the physician(s) providing continuing care within one month of diagnosis.

#224

- **Melanoma: Overutilization of Imaging Studies in Stage 0-IA Melanoma**
- Percentage of patients with stage 0 or IA melanoma, without signs or symptoms, for whom no diagnostic imaging studies were ordered.

 American Academy of Dermatology
Physicians' National Self-Assessment for Performance

Measure #224

- Details about the coding specifications for this measure will be included in later webinars, FAQ sheets, and tutorials out later this year
www.aad.org/QRS
- **IMPORTANT:** practices should start documenting in patient charts whether or not diagnostic imaging was ordered for history of melanoma and new melanoma patients

 American Academy of Dermatology

How do I get started with the 2011 PQRI program?

Step 1 • In March, 2011 - Go to www.aad.org/QRS

Step 2 • Click "Enroll Now!" button at the bottom of the page

Step 3 • Sign in using AAD Member ID and password
(this will be required for access every time)

Step 4 • Click on "2011 PQRI Melanoma Reporting" link

 American Academy of Dermatology

Other destructions

Vascular proliferative cutaneous lesions

- Specific to destruction of cutaneous vascular proliferative lesions: Port Wine and strawberry
- Based on treated area measured in square centimeters
- Only one code required for the total area treated
- 17106, 17107, or 17108 w/757.32

 American Academy of Dermatology and AAD Association

Laser application

- 17106, 17107 & 17108 used for:
 - port wine stains
 - strawberry hemangiomas
- **Use 17999** for:
 - acne
 - rosacea
 - telangiectasia

AAD American Academy of Dermatology and AAD Association
Physicians Dedicated to Excellence in Dermatology

Lipodystrophy: HIV depressed patient

- G0429 - Dermal filler injections for LDS
- DOS after - March 23, 2010
- Q2026, Radiesse 0.1 ml or
- Q2027, Sculptra 0.1 ml
- Report Both ICD9 DX:
 - 042 (HIV) and
 - 272.6 (Lipodystrophy)

AAD American Academy of Dermatology and AAD Association
Physicians Dedicated to Excellence in Dermatology

Scribing

- Acceptable
- Scribe writes word per word what the physician dictates
- Can not act independently
- Not covered by insurance
- Both MD & Scribe co sign note
- MD accountable

AAD American Academy of Dermatology and AAD Association
Physicians Dedicated to Excellence in Dermatology

Non-Physician Providers

- Certified
- Scope of practice
 - State laws
- Supervisor’s role

AAD American Academy of Dermatology and AAD Association
Physicians Dedicated to Excellence in Dermatology

- The Balanced Budget Act of 1997 (effective January 1, 1998) allowed NPs, PAs and CNSs to bill Medicare directly for services within their “scope of practice.”

AAD American Academy of Dermatology and AAD Association
Physicians Dedicated to Excellence in Dermatology

PA/NPP Websites

- Aetna allowing NP/PA claims – www.aetna.com
<http://www.aad.org/pm/billing/managedcare/>
- www.aapa.org
- www.dnanurse.org

AAD American Academy of Dermatology and AAD Association
Physicians Dedicated to Excellence in Dermatology

**Ordering and Referring
edit on hold**

- **PECOS**- Provider Enrollment Chain & Ownership System
- http://www.cms.gov/MedicareProviderSupEnroll/04_InternetbasedPECOS.asp#TopOfPage
Instructions: DCC Fall 2010

AAD American Academy of Dermatology and AAD Association
Physicians Dedicated to Excellence in Dermatology

Intralesional injections

- Not used for local anesthetic
- 11900-11901 - non chemo agents
- 96405-96406 – biologics or chemo agents
- Not reportable separately unless:
Different agents
- Report both Procedure & Drug

AAD American Academy of Dermatology and AAD Association
Physicians Dedicated to Excellence in Dermatology

How to report Candida for warts

- J3490 with 11900/11901
- The name of the drug
- The dosage administered
- The National Drug Code (NDC) number (consists of 11 digits)

AAD American Academy of Dermatology and AAD Association
Physicians Dedicated to Excellence in Dermatology

December 2004 cpt®Assistant, page 19

Eye and Ocular Adnexa, **67810** (Q&A)

Question - Would it be appropriate to report an integumentary system code for a biopsy involving the lid margin, tarsal plate, or palpebral conjunctiva?

AMA Comment - "From a CPT coding perspective, biopsies of the skin and subcutaneous tissues only are coded in the integumentary system and biopsies involving the lid margin, tarsal plate, or palpebral conjunctiva **should** be reported with code

67810, Biopsy of eyelid. Therefore, it would not be appropriate to report an integumentary system code for this procedure."

 American Academy of Dermatology

Mohs Micrographic Surgery

- Surgery & pathologic exam
- Biopsy, surgery & path
- 59 or 58 modifier
- Different day 2nd stage
 - WPS

74

 American Academy of Dermatology

MMS codes

- 17311 – 1st Stage face
 - +17312 – 2nd Stage
- 17313 – 1st Stage Trunk
 - +17314 – 2nd Stage
- 17315 – extra stages

75

 American Academy of Dermatology Association

Medically Unlikely Edit (MUE) now Published

- Reduce payment errors
- Not all codes listed
- Appeal as claim lines; not as units

http://www.cms.hhs.gov/NationalCorrectCodInitEd/08_MUE.asp#TopOfPage

 American Academy of Dermatology Association
Physicians Dedicated to Excellence in Dermatology

Correct Coding

- **Medicare NCCI Edits**
 - Updated quarterly
 - CMS website
 - Modifier -59 and -25
- http://www.cms.hhs.gov/NationalCorrectCodInitEd/01_overview.asp
- **Medically Unlikely Edits (MUE)** - excessive units of service
- **Other payers-** Their own rules

 American Academy of Dermatology Association
Physicians Dedicated to Excellence in Dermatology

NCCI Edits

- Develop correct coding
- Report most comprehensive code
- NCCI edit
 - Column 1/Column 2 codes
 - Mutually Exclusive code
- Use modifiers to report special cases

 American Academy of Dermatology Association
Physicians Dedicated to Excellence in Dermatology

NCCI Edits

CMS New Tool Kit

- **How to Use THE NATIONAL CORRECT CODING INITIATIVE (NCCI) TOOLS**
- <https://www.cms.gov/MLNProducts/downloads/How-To-Use-NCCI-Tools.pdf>

 American Academy of Dermatology Association
Physicians Dedicated to Excellence in Dermatology

Illinois RAC Contractor

Region B
CGI Technologies and Solutions,
Fairfax, Va.
1-877-316-7222
<http://racb.cgi.com/>

 American Academy of Dermatology Association
Physicians Dedicated to Excellence in Dermatology

Seven Tips to a RAC audit

1. Update your Company contact
2. Respond to RAC audit
3. Build a relationship
4. Use the discussion period
5. Use tamper proof mailers
6. Double check whatever is sent
7. Follow up

 American Academy of Dermatology Association
Physicians Dedicated to Excellence in Dermatology

What are audit triggers?

- Sudden increase in specific procedure
- Larger than normal high-level E&M codes.
- Large increase in the number of Medicare claims billed over a short period of time.
- Selection based on a service targeted in an OIG Work Plan.
- **“Whistle Blower” or Qui Tam action -**
 - **Whistle blowers receive up to 25% of recovered amounts.**

AAAD American Academy of Dermatology Association
Physicians Dedicated to Excellence in Dermatology

Other dermatology codes

- 10040 - do's and don'ts of billing for acne surgery/comedone extraction
Check with private payors

AAAD American Academy of Dermatology Association
Physicians Dedicated to Excellence in Dermatology

Adjacent tissue transfer

- Used if repair cannot be completed
- NCCI edits
 - **Included**
 - Preparing defect
 - Debridement
 - Tissue samples
 - **Not included**
 - Grafting

AAAD American Academy of Dermatology
Physicians Dedicated to Excellence in Dermatology

AMA clarified - 14301 & 14302

Two new 2010 adjacent tissue transfer codes:

14301 Adjacent tissue transfer or rearrangement, any area; defect 30.1 sq cm to 60.0 sq cm

+14302 each additional 30.0 sq cm, or part thereof (List separately in addition to code for primary procedure)

Code 14302 is an add-on code to be used with code 14301 when the adjacent tissue transfer is greater than 60 sq cm.

85

AAD American Academy of Dermatology

AMA Question - Should the total defect size of multiple areas be added together?

- If two or more separate adjacent tissue transfers were performed report each one separately UNLESS the lesions share contiguous borders.
- Site A was 90 sq cm and site B was 120 sq cm, having no contiguous borders, would be reported as:
- Site A – 90 sq cm: 14301, 14302 x 1 unit
- Site B – 120 sq cm 14301/59, 14302 x 2 units

86

AAD American Academy of Dermatology

Global package includes

- Dressing changes
- Local incision care
- Removal of sutures, staples, drains etc.
- Insertion, irrigation and removal of surgical caths, IV, trachs etc.
- Postop visits related to surgery recovery
- Preoperative visits after the decision is made to operate, beginning with the day before major surgery and the day of minor surgery

87

AAD American Academy of Dermatology and AAD Association

Global services

Includes:

- complications of the surgical procedure
- post op services related to the surgical procedure

http://www.wpsmedicare.com/part_b/policy/qsurg001.pdf

AAD American Academy of Dermatology and AAD Association
Physicians Dedicated to Excellence in Dermatology

GLOBAL MODIFIERS

- -58 - staged
- -79 - unrelated
- -24 – unrelated E/M

AAD American Academy of Dermatology
Physicians Dedicated to Excellence in Dermatology

Global services

Not included:

- Treatment for underlying condition
- Added course of Treatment not part of normal recovery process
- Treatment requiring return to OR

AAD American Academy of Dermatology
Physicians Dedicated to Excellence in Dermatology

Other Dermatology Codes

- **69090** - Ear Piercing
- **69110**- Excision External ear, partial, simple repair
- **17999**– Unlisted procedure, skin, mucous membrane & subcutaneous tissue

(Use for Blue light Tx for Acne)

 American Academy of Dermatology

Photochemotherapy (light box)

- 96910 – Photo Tx; tar and u/v B (or petrolatum & u/vB
- 96912 - psoralens & u/v A (PUVA)
- 96913 - Goeckerman and/or PUVA 4-8 hr

Reimbursement Issues

- Only used for 696.1, psoriasis
- NCCI edit 99211 can no longer be reported with 96910 & 96912

 American Academy of Dermatology

Psoriasis

- Laser treatment for inflammatory skin disease
 - 96920 - less 250 sq cm
 - 96921 - 250-500 sq cm
 - 96922 - over 500 sq cm

 American Academy of Dermatology

Hyperhidrosis

- 64650 - axillae
- 64653 - scalp
- 64999 - extremities
- **J0585 – Botox, per unit**

705.21 - Primary focal hyperhidrosis (NOS, axilla, face, palms, soles)

AAAD American Academy of Dermatology

Botulinum Toxin...

- Tx considered medically necessary when axillary hyperhidrosis is barely tolerable or in-tolerable and interferes with daily activities in spite of Tx with topical agents.

Note: Check payors coverage

- at least 6 months treatment with topical agents prior botox?

AAAD American Academy of Dermatology

Advance Beneficiary Notice (ABN)

- **New form:** English and Spanish **Why use?**
- Patient financial liability **When to use?**
- Expect denial in a specific case **How to use?**
- CMS - instructions must be specific to service being provided
- Give copy to patient & keep original in patient file

AAAD American Academy of Dermatology

ABN – CMS Directives

Not needed when:

- Service is statutorily **non-covered**. **Provider** is not required to issue ABN for statutorily excluded care
- Cosmetic service is covered for repair of accidental injury, etc.

If uncertain re: coverage, use ABN (source: CMS Health Insurance specialist)
<http://www.cms.hhs.gov/ContractorLearningResources/downloads/JA6136.pdf>

 American Academy of Dermatology

Medicare coverage modifiers

- GA – Patient signed ABN
- GY – Non-covered, patient request to file for secondary
- GZ – non-covered, patient didn't sign ABN
- GW – not related to the hospice patient's terminal condition

 American Academy of Dermatology

**Medicare exclusions
Non-covered services**

- Personal comfort items,
- Self-administered drugs and biologicals
- Cosmetic surgery (unless to repair an accidental injury or improvement of a malformed body member),
- Routine immunizations
- Routine physicals, lab tests and x-rays performed for screening purposes-except screening mammograms, screening Pap smears and various other mandated screening services),
- Routine foot care (cutting or trimming of corns or calluses, unless inflamed or infected, routine hygiene or palliative care),
- Custodial care, services furnished or paid by government institutions, services resulting from acts of war, and charges to Medicare for services furnished by a physician to immediate relatives or members of household

<http://new.cms.hhs.gov/BNI/Downloads/CMS20007English.pdf>

 American Academy of Dermatology

Commercial payer issues

- Cigna updated coding set requiring documentation to support use of Modifiers: 59 & 25 certain code sets
 - May attach to electronic claim via Box 19
- TriCare was applying multiple surgical to add on codes. Update – denied claims are being reprocessed for mass adjustment

Other payor issues

- Medicare Advantage denying 17000 & 17003 with AK diagnosis as not medically necessary
 - Appeal w/ NDC 250.4
- Some BCBS denying trunk repairs (12031) on lesions of 1.0 cm or less.
 - Hard edit similar to CMS & Aetna

Medicare Advantage

- Per April 2010 Federal Registry, MA fraud training requirement lifted
- Continue to review patient's coverage as Medicare cuts have caused premium raises and less benefits

Medicare Advantage Disputes

- Carrier not following CMS Part B guidelines or fee schedule
- Contact First Coast Service Options QIC
- Dispute can be filled by form letter, email or fax

<http://www.fcso.com/140759.pdf>

103

AAD American Academy of Dermatology

CMS Business update

- **Medicare payments may be reduced if the IRS needs to collect overdue taxes from a provider**

<http://www.cms.hhs.gov/MLNMattersArticles/downloads/MM6125.pdf>

2011 Part B Medicare

- Deductible \$162 per year
- Coinsurance 20 percent

105

AAD American Academy of Dermatology



2011 AAD Coding & Documentation Manual

Order a copy for your practice
AAD Coding & Documentation Manual
at
www.aad.org/education/resources/index.html
Or call
866-503-7546 ext. 4000

DermCoding Consult
Member benefit of a
Quarterly Coding publication



105

AAD Code busters?

ppm1@aad.org or

Fax: 847/330-1120

fmcnicholas@aad.org

peiden@aad.org

cbracy@aad.org

Electronic Health Records and Meaningful Use

 *American Academy of Dermatology and AAD Association*
Physicians Dedicated to Excellence in Dermatology™

Electronic Health Records (EHRs) and Meaningful Use



Rachna Chaudhari, MPH
Manager, Practice Management
American Academy of Dermatology
rchaudhari@aad.org

I do not have any relevant relationships with industry.

Presentation Summary

- Objectives:
 - Understand the federal government’s EHR Incentive Program guidelines
 - Learn how to become a meaningful user of EHRs
 - Assess how your practice should react to the current EHR marketplace

 *American Academy of Dermatology*
Physicians Dedicated to Excellence in Dermatology™

CMS EHR Incentive Program

- February 2009: ARRA and HITECH
- \$19 billion in incentives to Medicare/Medicaid providers over 10 years
- Goal: Increase adoption rate of EHR

 *American Academy of Dermatology*
Physicians Dedicated to Excellence in Dermatology™

CMS EHR Incentive Program

- Three requirements to achieve incentives:
 - Must use a certified EHR system
 - <http://onc-chpl.force.com/ehrcert>
 - Must be a meaningful user
 - Must submit clinical quality measures

 American Academy of Dermatology
© 2010 American Academy of Dermatology. All rights reserved.

CMS EHR Incentive Program

- Several types of CMS EHR Incentive Programs
 - Medicare EHR Incentive Program
 - Medicaid EHR Incentive Program
 - Hospital EHR Incentive Program
 - Medicare Advantage EHR Incentive Program

 American Academy of Dermatology
© 2010 American Academy of Dermatology. All rights reserved.

**CMS EHR Incentive Program:
Eligibility Requirements**

- Medicare EHR Incentive Program
 - Doctors of Medicine or Osteopathy
 - Doctors of Dental Surgery or Dental Medicine
 - Doctors of Podiatric Medicine
 - Doctors of Optometry
 - Chiropractors

Note: Medicare providers may not be hospital-based. A Medicare provider is considered hospital based if 90% or more of the provider's services are performed in a hospital inpatient or emergency room setting.

 American Academy of Dermatology
© 2010 American Academy of Dermatology. All rights reserved.

CMS Medicare EHR Incentive Program Payment

YEAR OF ADOPTION	PAYMENT YEAR							TOTAL INCENTIVE	PENALTY
	2011	2012	2013	2014	2015	2016			
2011	\$18,000	\$12,000	\$8,000	\$4,000	\$2,000		\$44,000		
2012		\$18,000	\$12,000	\$8,000	\$4,000	\$2,000	\$44,000		
2013			\$15,000	\$12,000	\$8,000	\$4,000	\$39,000		
2014				\$12,000	\$8,000	\$4,000	\$24,000		
2015								1%	
2016								2%	
2017 and beyond								3%	

AAD American Academy of Dermatology

CMS EHR Incentive Program: Eligibility Requirements

- Medicaid EHR Incentive Program
 - Providers
 - Physicians (Pediatricians have special eligibility and payment rules)
 - Nurse Practitioners (NPs)
 - Certified Nurse-Midwives (CNMs)
 - Dentists
 - Physician Assistants (PAs) who provide services in a Federally Qualified Health Center (FQHC) or rural health clinic (RHC) that is led by a PA
 - Have a minimum 30% Medicaid patient volume
 - Have a minimum 20% Medicaid patient volume, and is a pediatrician
 - Practice predominantly in a Federally Qualified Health Center or Rural Health Center and have a minimum 30% patient volume attributable to needy individuals

AAD American Academy of Dermatology

CMS Medicaid EHR Incentive Program Payment

YEAR OF ADOPTION	PAYMENT YEAR											TOTAL INCENTIVE
	2011	2012	2013	2014	2015	2016	2017	2018	2019	2020	2021	
2011	\$21,250	\$8,500	\$8,500	\$8,500	\$8,500	\$8,500						\$63,750
2012		\$21,250	\$8,500	\$8,500	\$8,500	\$8,500	\$8,500					\$63,750
2013			\$21,250	\$8,500	\$8,500	\$8,500	\$8,500	\$8,500				\$63,750
2014				\$21,250	\$8,500	\$8,500	\$8,500	\$8,500	\$8,500			\$63,750
2015					\$21,250	\$8,500	\$8,500	\$8,500	\$8,500	\$8,500		\$63,750
2016						\$21,250	\$8,500	\$8,500	\$8,500	\$8,500	\$8,500	\$63,750

AAD American Academy of Dermatology

CMS Medicare EHR Incentive Program

- Registration
 - Providers must register on the CMS website
 - <https://ehrincentives.cms.gov/hitech/login.action>
 - Providers must be enrolled in Medicare FFS or Medicare Advantage
 - Providers must have a National Provider Identifier (NPI)
 - Providers must be enrolled in PECOS

 American Academy of Dermatology

CMS Medicare EHR Incentive Program

- Reporting
 - You can only report in successive payment years.
 - The first reporting year is for a 90 day period.
 - The 2nd, 3rd, 4th and 5th reporting years are for the full year.
 - You cannot receive a bonus from both the e-prescribing incentive program and the EHR incentive program.

 American Academy of Dermatology

CMS Medicare EHR Incentive Program

- Criteria
 - Providers will need to report a set of measures to achieve “meaningful use”
 - Measures are based on a set of stages

First Payment Year	Payment Year				
	2011	2012	2013	2014	2015
2011	Stage 1	Stage 1	Stage 2	Stage 2	TBD
2012		Stage 1	Stage 1	Stage 2	TBD
2013			Stage 1	Stage 1	TBD
2014				Stage 1	TBD

 American Academy of Dermatology

CMS Medicare EHR Incentive Program

- Providers will need to report a total of 15 core measures
 - One of these core measures is the reporting of quality measures whereby a provider would need to report a total of 6 quality measures
 - Quality measures will require electronic submission by 2012
 - Quality measures will only need to be reported once per year
- Providers will need to report a total of 5 additional measures from a menu set

 American Academy of Dermatology

CMS Medicare EHR Incentive Program – Core Measures to Report

Measure	Exception
Perform Computer Physician Order Entry (CPOE) on 30% of all patients	Providers who write fewer than 100 prescriptions in the reporting period
Implement drug to drug and drug allergy checks	None
Electronically prescribe for 40% of all patients	Providers who write fewer than 100 prescriptions in the reporting period
Maintain an up to date problem list of current and active diagnoses on 80% of all patients	None
Maintain active medication list for 80% of all patients	None

 American Academy of Dermatology

CMS Medicare EHR Incentive Program – Core Measures to Report

Measure	Exception
Maintain active medication allergy list for 80% of all patients	None
Record preferred language, gender, race, ethnicity and date of birth for 50% of all patients	None
Record vital signs for 50% of all patients age 2 and over	Providers who do not collect vital signs may report this measure does not apply
Record smoking status of 50% of all patients 13 years and older	Providers who do not see patients over the age of 13
Implement one clinical decision support rule relevant to the specialty along with the ability to track compliance with that rule	None

 American Academy of Dermatology

CMS Medicare EHR Incentive Program – Core Measures to Report

Measure	Exception
Provide at least 50% of all patients with an electronic copy of their health information who request it	Providers who do not receive a request from patients for this information
Provide clinical summaries for at least 50% of all patients for each office visit – exception for providers who do not have office visits	Providers who have no office visits
Electronically exchange key clinical information	None
Protect electronic health information created or maintained by the EHR	None
Report clinical quality measures	Providers can report numerators or denominators of zero

American Academy of Dermatology Association

CMS Medicare EHR Incentive Program – Menu Measures to Report (Providers Only Need to Report Five Measures)

1. Implement drug-formulary checks.
6. Use certified EHR to identify patient-specific education resources and provide resources to patient if appropriate.
2. Incorporate clinical lab-tests results into certified EHR technology as structured data.
7. Perform medication reconciliation for patients.
3. Generate at least one report listing patients of the provider with a specific condition.
8. Provide summary of care record for each transition of care or referral.
4. Send reminders to patients per patient preference for preventive/follow up care.
9. Capability to submit electronic data to immunization registries.
5. Provide patients with timely electronic access to their health information.
10. Capability to submit electronic syndromic surveillance data to public health agencies.

American Academy of Dermatology Association

CMS Electronic Prescribing Incentive Program

- There is a separate e-prescribing program through CMS!
- All Medicare providers (e.g. physicians, NPs, PAs, etc.) are eligible to earn a 1 percent incentive on their total Medicare Part B allowed charges by electronically prescribing a total of 25 times in 2011.
- Program begins instituting penalties in 2012:

Year	Incentive	Penalty
2011	1%	0%
2012	1%	-1%
2013	0.5%	-1.5%
2014 and beyond	0%	-2%

- You must report on your claims before June 30, 2011 to avoid a penalty in 2012 and 2013.

American Academy of Dermatology Association

CMS Electronic Prescribing Incentive Program: Reporting Requirements

If you:	Report:	Frequency:	Before:
Successfully created an electronic prescription	G8553 along with the applicable denominator code*	25 times	June 30, 2011
Do not have at least 100 cases containing an encounter code in the measure denominator* between Jan. 1 – June 30, 2011	N/A; CMS will calculate this and exempt you from the penalty in 2012	N/A	June 30, 2011
Do not have prescribing authority	G8644	1 time	June 30, 2011
Have less than 10 percent of your total allowed charges comprised of codes in the denominator* between Jan. 1 and June 30, 2011	N/A; CMS will calculate this and exempt you from the penalty in 2012	N/A	June 30, 2011
If you practice in a rural area without sufficient high speed internet access	G8642	1 time	June 30, 2011
If you practice in an area without sufficient access to pharmacies that accept electronic prescriptions	G8643	1 time	June 30, 2011

Denominator codes include: 90801, 90802, 90804-90809, 90862, 92002, 92004, 92012, 92014, 96150-96152, 99201-99205, 99211-99215, 99304-99310, 99315, 99316, 99324-99328, 99334-99337, 99341-99345, 99347-99350, G0101, G0108, and G0109



Next Steps

- If you currently don't have an EHR
 - Make sure you purchase one that meets the meaningful use criteria
 - Check for dermatology specific CCHIT certification
 - Analyze workflows and how they will change
- If you currently do have an EHR
 - Contact your vendor to find out if they will provide free updates
 - Analyze workflows to determine how they will need to change



Summary

- Up to \$44,000 available through the CMS Medicare EHR Incentive Program
- Up to \$63,750 available through the CMS Medicaid EHR Incentive Program
- Penalties begin in 2015
- For more information:
 - <http://www.cms.gov/EHRIncentivePrograms/>
 - <http://www.aad.org/hitkit>



Healthcare Reform

- March 23, 2010: President Obama signed the Patient Protection and Affordable Care Act into law
- Numerous provisions begin going into effect in 2010 and last until 2020
 - Reimbursement changes
 - Quality changes
 - Compliance programs
 - Administrative simplification

 American Academy of Dermatology

Healthcare Reform: Reimbursement Changes

- 2010: HHS is given the authority to identify and adjust the relative value units of services under the physician fee schedule
- 2011: Medicare Advantage payments frozen to 2010 levels
- 2012: Center for Medicare and Medicaid Innovation Center (CMI) launched
- 2012: Value-based modifier regulations published

 American Academy of Dermatology

Healthcare Reform: Reimbursement Changes

- 2013: National Pilot Program on Payment Bundling
 - Five year voluntary pilot program focused on paying for bundled services
- 2014: Independent Payment Advisory Board (IPAB) established
 - IPAB will be given the authority to make policy recommendations to Medicare to reduce cost
 - Board members are appointed by the President

 American Academy of Dermatology

Healthcare Reform: Quality Changes

- Physician Resource Use and Measurement Reporting Program (PRUMP)
 - CMS will send reports to individual physicians by 2012 measuring the resources they use to care for Medicare patients
- Physician Compare website will be launched in 2011

 American Academy of Dermatology

Healthcare Reform: Quality Changes

- PQRS
 - 2010: 2% bonus
 - 2011: 1% bonus + 0.5% bonus for MOC
 - 2012: 0.5% bonus + 0.5% bonus for MOC
 - 2013: 0.5% bonus + 0.5% bonus for MOC
 - 2014: 0.5% bonus + 0.5% bonus for MOC
 - 2015: Penalty of -1.5% for not participating in PQRS
 - 2016 and beyond: Penalty of -2% for not participating in PQRS

 American Academy of Dermatology

Healthcare Reform: Employer Requirements

- Small business tax credits begin in 2010
 - Eligibility rules: Less than 25 full-time-equivalent employees with average wages of less than \$50,000
 - Receive a tax credit up to 35% of an employer's contribution for health insurance premium
 - Tax credit rises to 50% in 2014
- All employers required to report the value of employees' health care benefits on W-2 in 2011
- Penalties begin in 2014
 - Applies to employers with more than 50 employees who do not offer insurance coverage and have at least one full-time employee who receives the premium assistance tax credit

 American Academy of Dermatology

Healthcare Reform: Compliance Requirements

- Provider screening
 - All Medicare and Medicaid providers will undergo additional application procedures
 - New providers: March 2011
 - Existing providers: March 2012
 - New providers may be subject to probationary period

 American Academy of Dermatology

Healthcare Reform: Compliance Requirements

- Recovery Audit Contractors (RACs)
 - RACs will be expanded to cover Medicare, Medicaid, Medicare Advantage and prescription drug plans
- PECOS
 - All physicians ordering or referring services must be enrolled
- NPI
 - All providers must include their NPI number on enrollment applications and claims

 American Academy of Dermatology

Healthcare Reform: Administrative Simplification

- The American Medical Association (AMA) wrote this portion of the law
- Affects eligibility and claim status electronic transactions
- Potential to create uniform claims forms, greater transparency and consistency in claim edits

 American Academy of Dermatology

Healthcare Reform: Administrative Simplification

- Electronic funds transfers (EFT) will most likely be required
 - Rules will be released in 2011
- ICD-9 to ICD-10 crosswalk will be provided
- Rules on health claims attachments and referral/authorization standards will be released in 2014

Healthcare Reform – Next Steps

- Keep checking CMS and/or specialty societies' websites
 - <http://www.aad.org/gov/hsr>
- Begin participating in PQRI, e-rx or EHR incentive programs to avoid penalties
- Self-audit your practice to insure proper compliance
- Consult a tax attorney to determine health care insurance benefits for employees

Overall Incentives Available

YEAR	EHR INCENTIVE*	E-PRESCRIBING INCENTIVE*	PQRI INCENTIVE	MOC INCENTIVE	TOTAL INCENTIVES AVAILABLE
2010	\$0	2%	2%	0%	4%
2011	\$44,000 (dispersed over a 5 year period)	1%	1%	0.5%	2.5% OR \$44,000 + 1.5%
2012	\$44,000 (dispersed over a 5 year period)	1%	0.5%	0.5%	2% OR \$44,000 + 1%
2013	\$39,000 (dispersed over a 4 year period)	0.5%	0.5%	0.5%	1.5% OR \$39,000 + 1%
2014	\$24,000 (dispersed over a 3 year period)	0%	0.5%	0.5%	1% + \$24,000

Note: Percentages based on Medicare Part B allowed charges. *EHR and e-prescribing incentive cannot be combined. Providers must select one program to participate in.

Overall Penalties				
YEAR	EHR PENALTY*	E-PRESCRIBING PENALTY*	PQRI PENALTY	TOTAL PENALTIES
2012	0%	1%	0%	1%
2013	0%	1.5%	0%	1.5%
2014	0%	2%	0%	2%
2015	1%	2%	1.5%	4.5%
2016	2%	2%	2%	6%
2017 and beyond	3%	2%	2%	7%

Note: Percentages based on Medicare Part B allowed charges.
*EHR and e-prescribing incentive cannot be combined. Providers must select one program to participate in.

 *American Academy of Dermatology*

Additional Materials

Shave Removal Versus Biopsy with Shave Technique Versus Excision – How Do They Differ?

This article was prepared by James A. Zalla, MD and reviewed by the members of the AAD Coding & Reimbursement Task Force in February 2008.

According to AMA CPT, shaving is the sharp removal by transverse incision or horizontal slicing to remove epidermal and dermal lesions without a full thickness dermal excision. This includes local anesthesia, chemical or electrocauterization of the wound, and does not require suture closure.

A shave removal is a distinct procedure, intended to remove a lesion or the problematic portion of the lesion. Removed tissue is also typically submitted for pathologic examination; however, the obtaining of that tissue is not a separate biopsy procedure and may not be coded as such. Only the shave removal code would be reported.

Shaving of epidermal or dermal lesions (11300-11313) is not considered an "excision" and excision codes (11400-11646) would not be used to report these services. The "removal" of a lesion by the shave technique requires a more superficial "removal" than an excision procedure in the integumentary system, but does not require complete removal of the lesion. Shave removal does not involve the full thickness of the dermis, whereas excision codes require removal of the entire thickness of the dermis through to the subcutaneous tissue.

The following examples illustrate different methods used in the shave removal, biopsy, destruction, and excision of dermal and epidermal lesions and their corresponding proper coding.

EXAMPLE 1

A man has a 0.7 cm raised benign dermal nevus on his cheek which is being cut while shaving. Such lesions arise deeper in the dermis but are not problematic unless they raise above the level of the adjacent skin. Appropriate treatment is to remove the raised component of such a lesion with the shave technique, a "shave removal," recognizing that the remainder of this benign lesion persists down in the dermis after the procedure and a complete removal is neither intended nor desirable. The fact that the removed tissue may then be sent for pathologic examination and confirmation, primarily for medical legal reasons, does not make this procedure a biopsy procedure. The intent of the procedure is therapeutic rather than diagnostic, and the histopathology is done for confirmatory reasons. Example 1 is reported with CPT 11311 for shaving this 0.7 cm facial lesion.

EXAMPLE 2

A patient presents with a pearly nodule on the left nasal ala. The dermatologist recognizes that this appears to be a deeper lesion that could be a basal cell cancer, and a prudent approach would be to biopsy it for confirmation. A commonly used technique would be to biopsy the raised component of that lesion using a shave technique to remove the elevated portion specifically for pathologic exam, with

the intent that if it is a basal cell cancer, subsequent definitive treatment will then be undertaken. A shave technique may be selected in this instance because if the lesion on pathology exam is shown to be a benign dermal nevus, a deeper scar from the biopsy would have been avoided. In this example, it does not matter, for coding purposes, whether the physician selected a razor, a curette, a punch, or a scalpel as the instrument for the biopsy; they would all be coded the same. The primary purpose of the procedure is to obtain tissue for pathologic examination. This second example is appropriately coded as a skin biopsy procedure, CPT 11100.

The fact that a pathology report may state "specimen consists of a shave specimen of skin" does not mean anything in deciding whether the procedure represents a skin biopsy by the shave technique versus a shave removal of a lesion that happened to be submitted for pathologic confirmation.

An instrument such as a razor blade is one of a number of instruments that may be used for either a shave removal or a skin biopsy, depending on the intent of the physician. CPT codes 11300-11313, which are defined by the shaving technique used to remove the lesion, may be reported for either benign or malignant lesions. The appropriate code is selected based on the anatomic site and the largest diameter size of the lesion itself, not including any additional margin.

Documentation in the medical record would include some indication for the procedure. In the case of a skin biopsy procedure, documentation such as "suspicious lesion," "changing mole," "history of bleeding lesion," "variable pigmentation," or "atypical appearing nevus," or other similar descriptor can be extremely helpful in establishing the reason for the procedure. Similarly, documentation for a shave removal procedure might include "symptomatic lesion," "rubs on waistband or bra," "hits lesion shaving," or other reasons why an elevated lesion is best removed with the shave technique.

An excision procedure, whether for benign or malignant lesions, is defined as full thickness (through the dermis) removal of a lesion including margins, and if a simple (non-layered) closure is performed, it is included in the excision procedure. Each excised lesion is coded separately, and code selection is determined by measuring the greatest clinical diameter of the apparent lesion plus that margin required for complete excision (lesion diameter plus the most narrow margin required equals the excised diameter). The measurement of lesion plus margin is made prior to excision.

If the defect following an excision goes "through the entire thickness of the dermis," it is considered an excision even though the defect may not be closed. Sometimes dermatologists use a deeper tangential removal known as "saucerization" that may go through the dermis into fat. This may be done in the case of suspected melanomas to assure that the complete depth of the lesion is available for pathology. Such lesions are intentionally left open pending pathology

— see **Shave Removal** on page 8

Shave Removal

— continued from page 7

exam, anticipating a more definitive excision procedure will be needed. Such saucerization procedures are appropriately coded as excisions with the 11400 or 11600 series depending on whether the lesion was pathologically determined to be benign or malignant. Because such procedures go “through the dermis,” they exceed the definition of shave removal procedures that would be coded in the 11300 series.

If fat is present on a clinically excised specimen, or demonstrated on the corresponding pathology slide, it is clear that the excision had to extend through the dermis. There may, however, be instances in some body areas that lack subcutaneous tissue in which a specimen may include the full thickness of the dermis at that site but not have underlying fat.

It is also possible that a specimen may extend the full thickness through the dermis into fat, but the fat may pull away from the dermal specimen as it is harvested or in tissue processing for pathology. In such instances, the tissue slides would normally demonstrate that the full thickness of dermis was included on the specimen.

A shave removal procedure may vary in depth and width, and in some instances it may completely remove a lesion that occupies the upper or mid dermis. The fact that a lesion is removed in its entirety is irrelevant when deciding whether to code as a shave removal or an excision. A lesion may be completely removed, but if the level of removal does not go through the full thickness of dermis, it is not an “excision” according to CPT. Such descriptors in CPT are to be used by physicians and billers as well as carriers, and recognition of the same criteria by all allows for consistency of coding and fairness of payment.

While as a general surgical concept, the notion of excision may connote complete removal, in the integumentary section of CPT, the shave removal procedure codes specifically do not use the term “excision” to avoid confusion, and no reference is made to whether the lesion is partially or completely removed.

EXAMPLE 3

A 17 y/o girl has a 1.1 cm raised brown nevus on her mid back that rubs on her bra. Her dermatologist removes it using a shave technique. Pathology report shows a benign compound nevus, and the lateral and underlying dermal margins are clear, confirming complete removal of the nevus. This procedure is properly coded 11302, shave removal benign lesion trunk, 1.1-2.0 cm. It is not coded as an excision, despite the fact that it was “completely” removed.

EXAMPLE 4

A 50 y/o boater has a discreet but irregular 8mm shiny red flat lesion on his back. The clinical diagnosis is probable superficial basal cell skin cancer, and the dermatologist elects to shave the lesion at the level of the mid dermis. If

the intent of this procedure was therapeutic, it is appropriately coded as a shave removal, code 11301. If the intent of this procedure was diagnostic, it would be coded as a skin biopsy, code 11100. However, some dermatologists would immediately follow obtaining the specimen for pathology with curettage as a definitive procedure with the therapeutic intent to cure. Assuming the pathology confirmed the diagnosis of basal cell cancer, the latter procedure is properly coded as a malignant destruction trunk, 0.6-1.0 cm, 17261. If pathology confirmed a benign diagnosis, the procedure code 17110, destruction of a benign lesion would be reported. If pathology, however, confirmed an actinic keratosis, the destruction procedure code 17000 would be reported. In either case, only the definitive procedure is reported. Since obtaining tissue for pathology is a component of the definitive procedure, a skin biopsy is not separately reported for the same lesion.

EXAMPLE 5

A 1.2 cm flesh colored polypoid nodule on the upper thigh of a 45 y/o man is irritated by his clothing. It is removed at the base with scissors, exposing underlying fat, and hemostasis is achieved with electrocautery. Pathology confirms a benign fibrofatty polyp.

This procedure is properly coded as 11402, excision benign lesion leg, 1.1-2.0 cm.

EXAMPLE 6

A 0.6 cm flat red to black lesion on the arm of a 32 y/o tanning bed user is diagnosed as probable pigmented basal cell cancer, with melanoma a less likely consideration. The lesion is shaved off with a blade including a 0.2 cm margin. The wound base is then lightly electrodesiccated and curetted, leaving a 1.0 cm wound. Pathology confirms a pigmented basal cell carcinoma, and the deep and lateral margins are uninvolved.

This procedure is properly coded as 17261, destruction malignant lesion arm, 0.6-1.0 cm diameter. It is not coded as an excision, since the level of removal did not extend through the dermis. It is not coded as a shave removal, since the lesion was destroyed after the specimen was obtained for pathology.

EXAMPLE 7

A 55 y/o man has a 0.9 cm dark brown shiny nodule on the upper back, diagnosed as probable nodular melanoma. The lesion is excised as an ellipse, including a 0.3 cm margin, and a 4.2 cm layered repair is performed. Pathology confirms a level III nodular melanoma, Breslow thickness 2.80 mm, margins uninvolved, and definitive wide excision is scheduled.

The initial procedures are properly coded 11602, Excision malignant lesion trunk 1.1-2.0 cm for the excised diameter of 1.5 cm, and intermediate repair 12032, Layered closure trunk 2.6-7.5 cm. The documentation in the medical record must describe and support the use of the intermediate repair code.*